

Vorhanden

Touica

2000W 200V 10A

2000W 100V 20A

TedQuics CD - Cass - Receiver

HTM - CD - Receiver 229,-

Kauf ? : Supersec - CD - Receiver 299,-

Aira Mini Anlage (Cass. Radio) 399,- CD

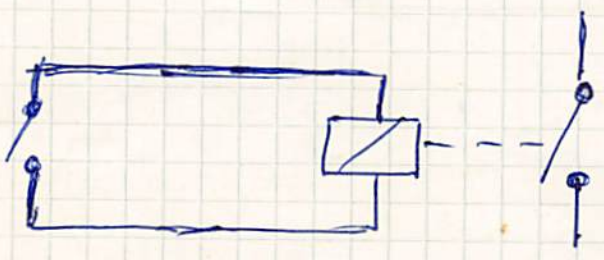
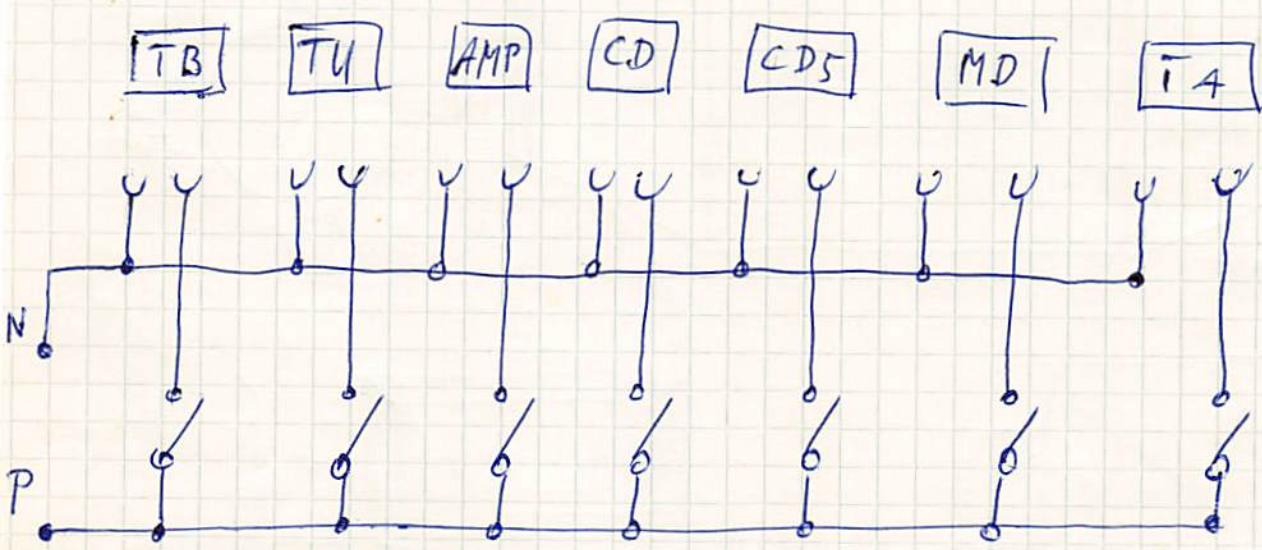

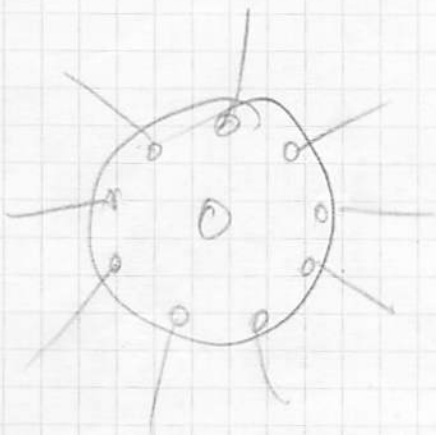
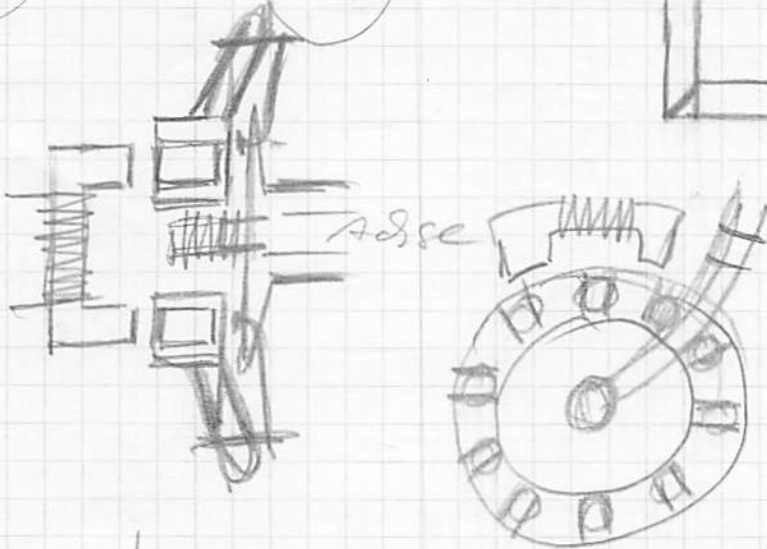
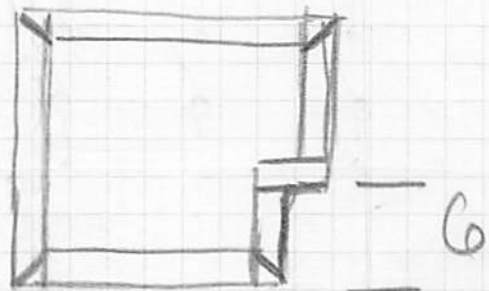
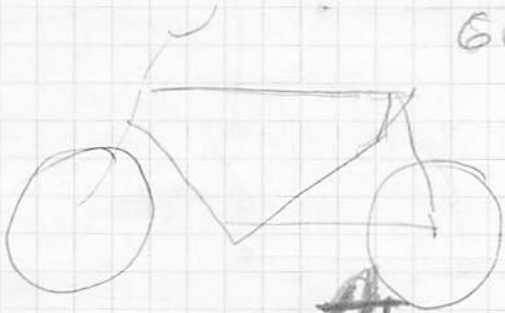
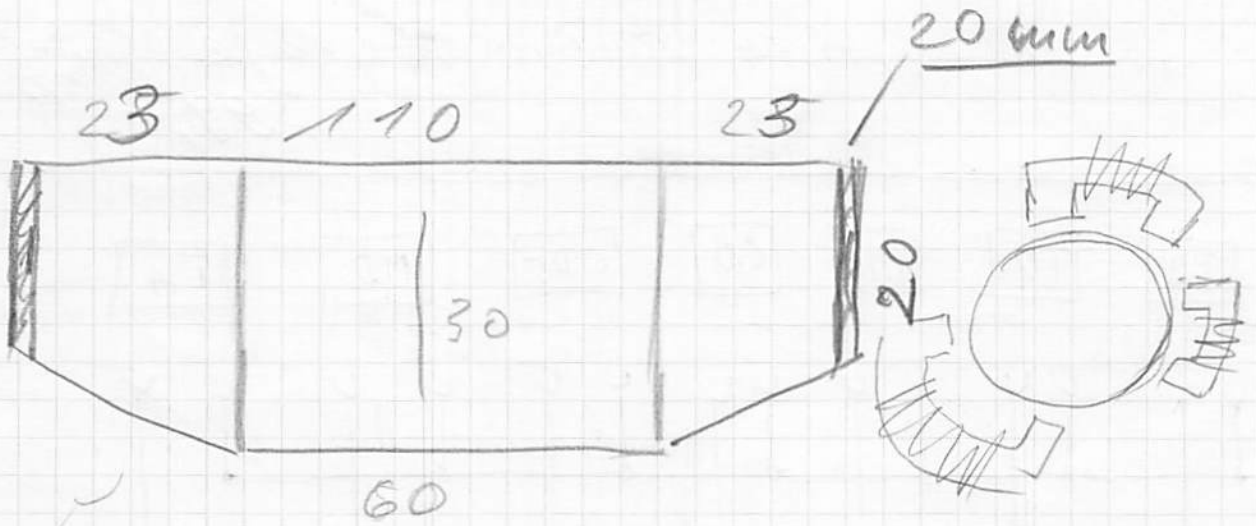
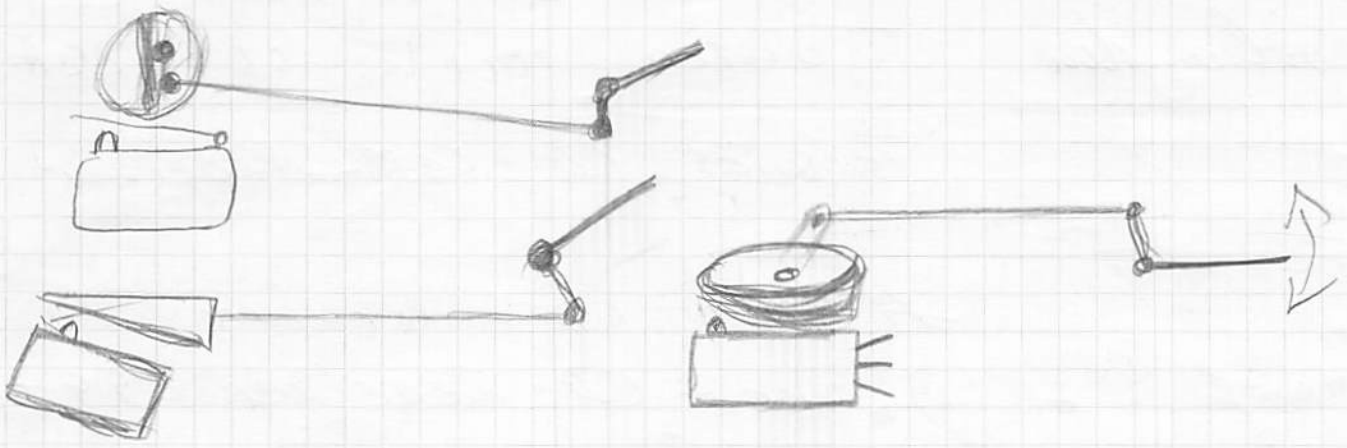

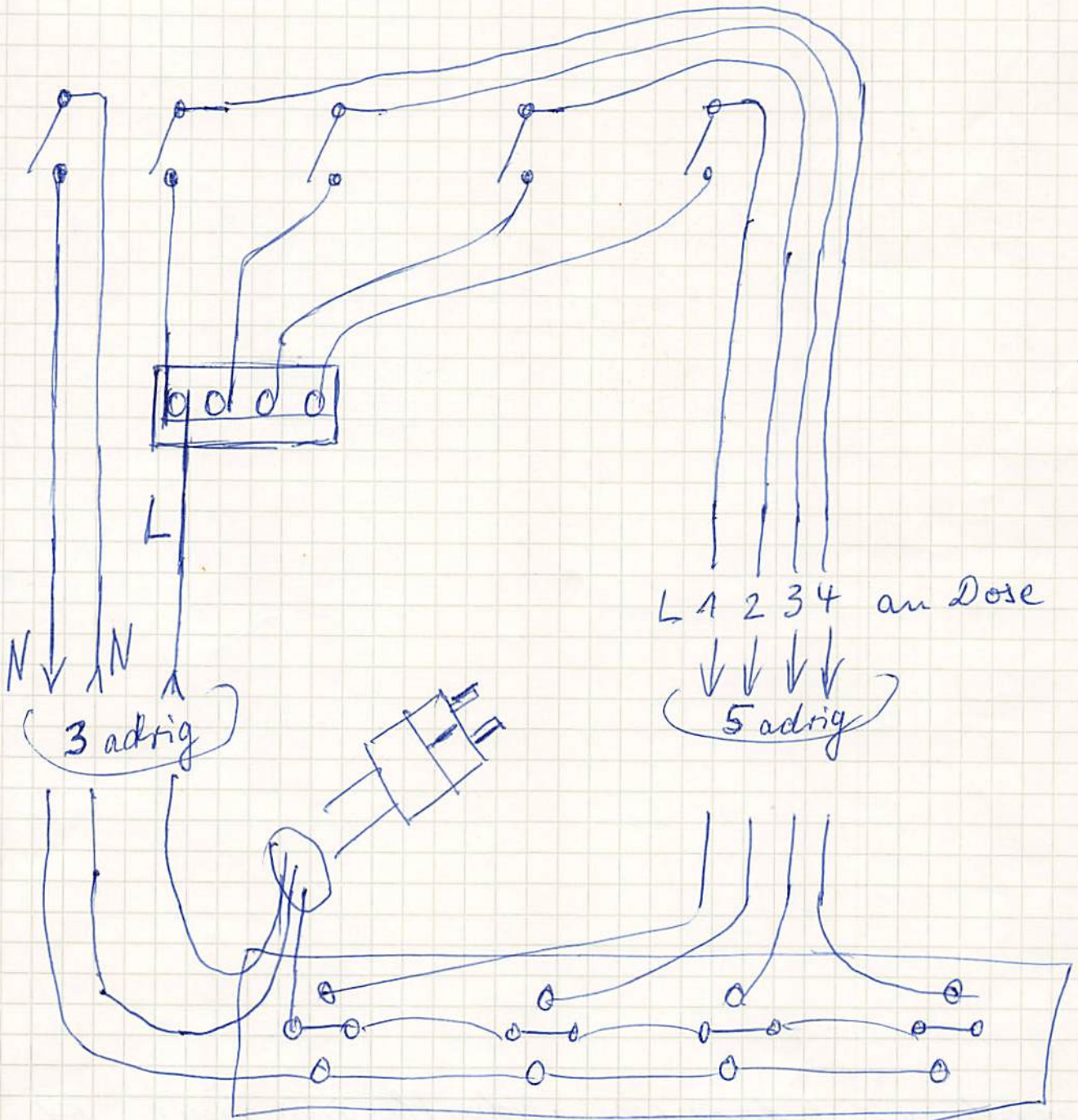
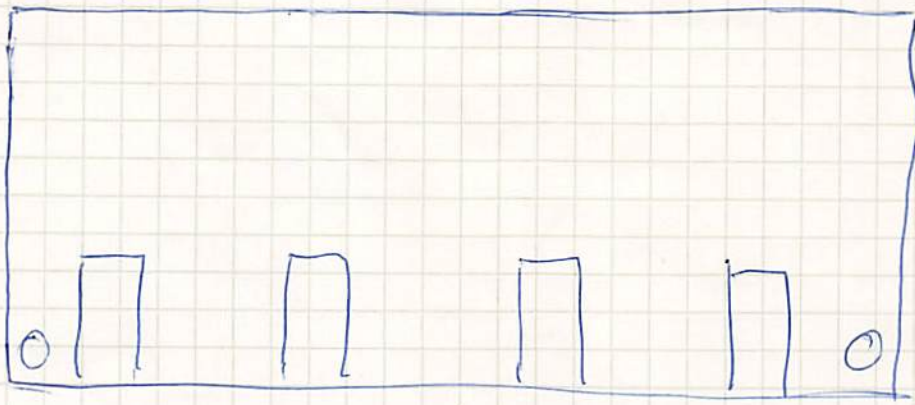

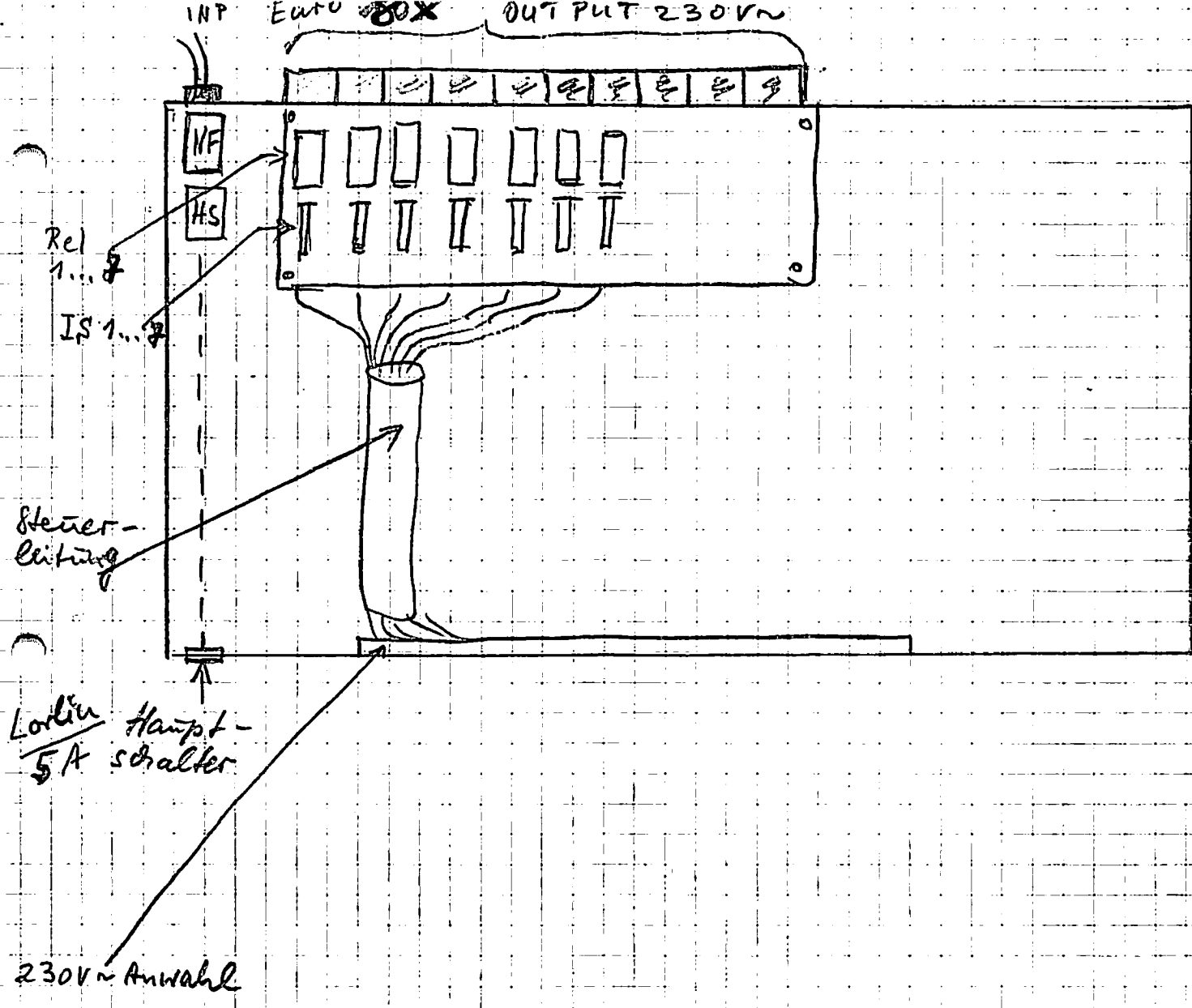

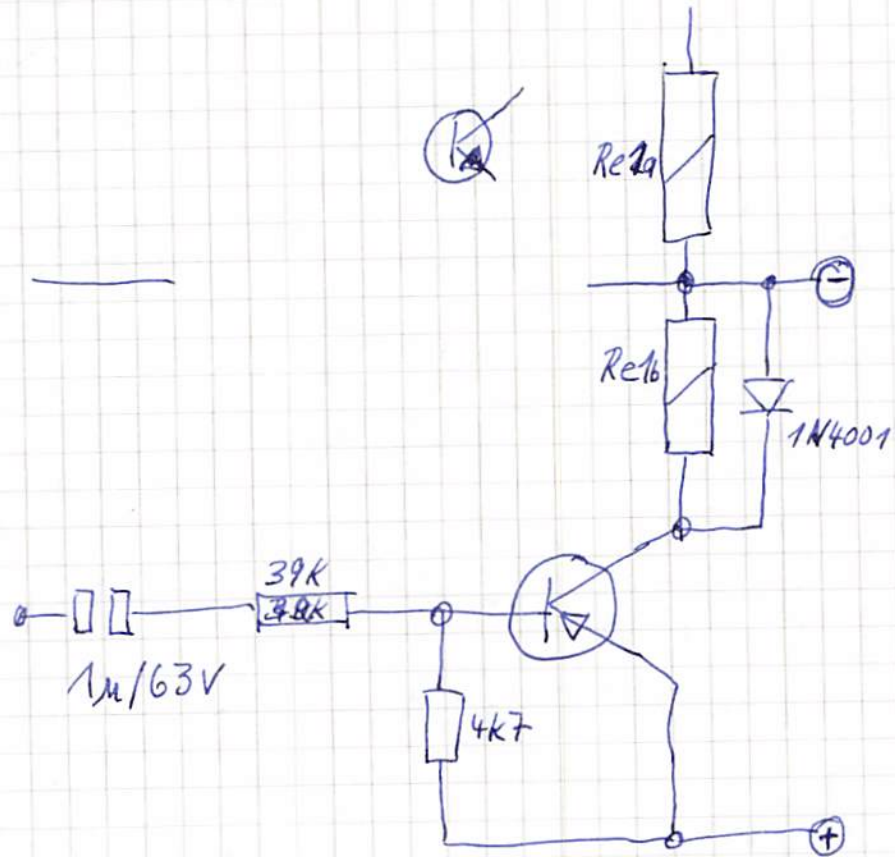

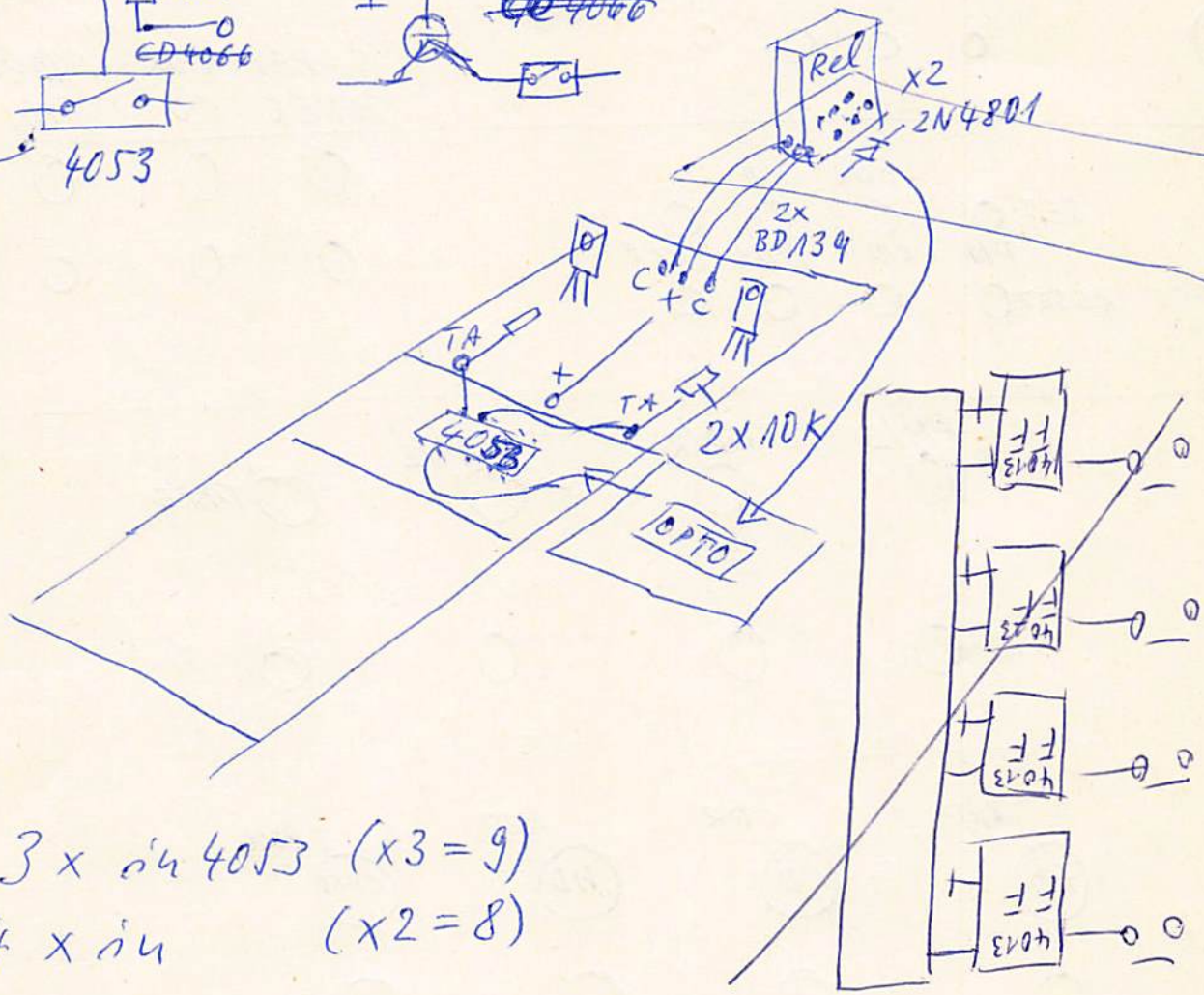
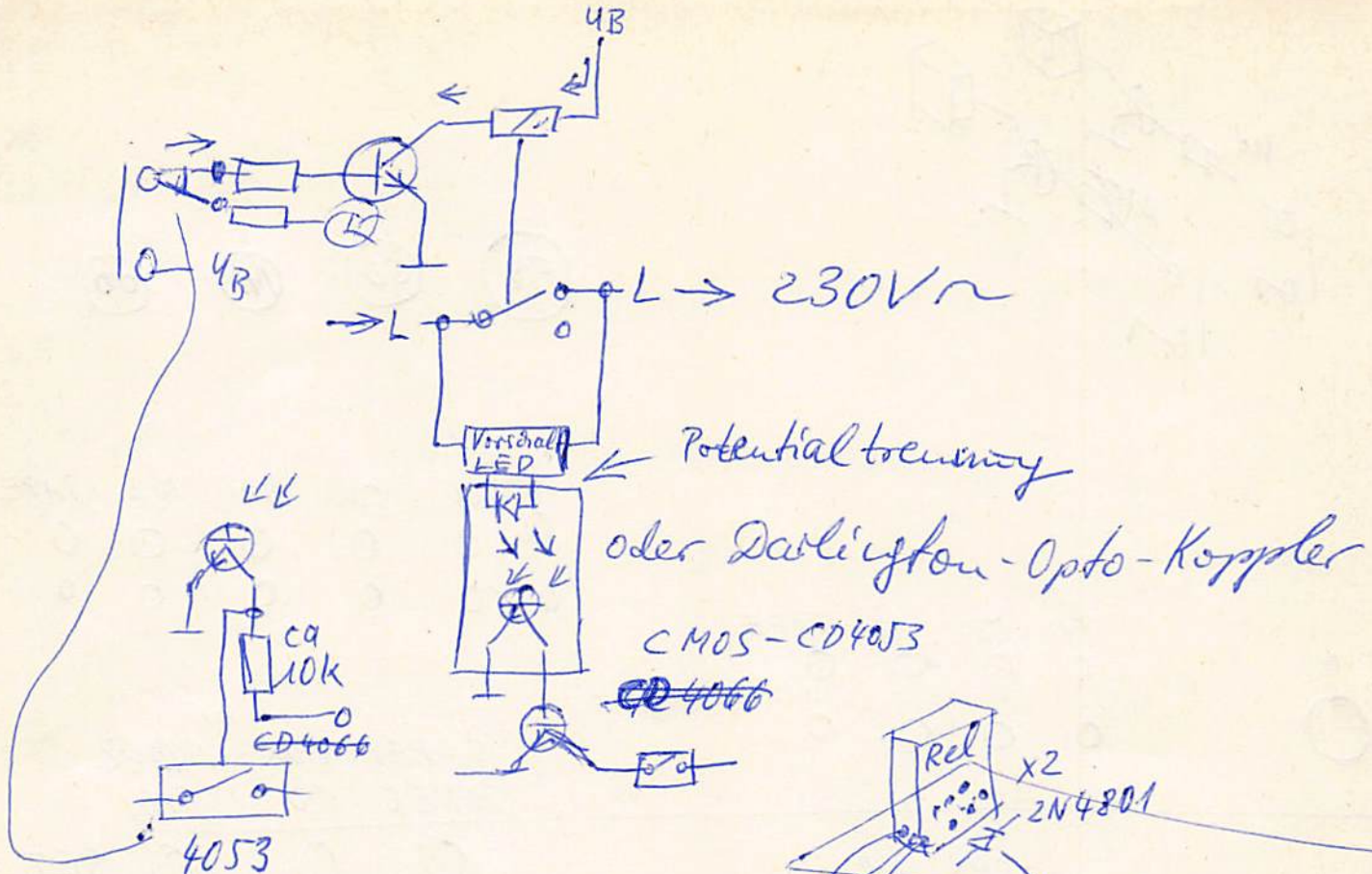

3 x 04 4053 (x3 = 9)

4 x 04 (x2 = 8)

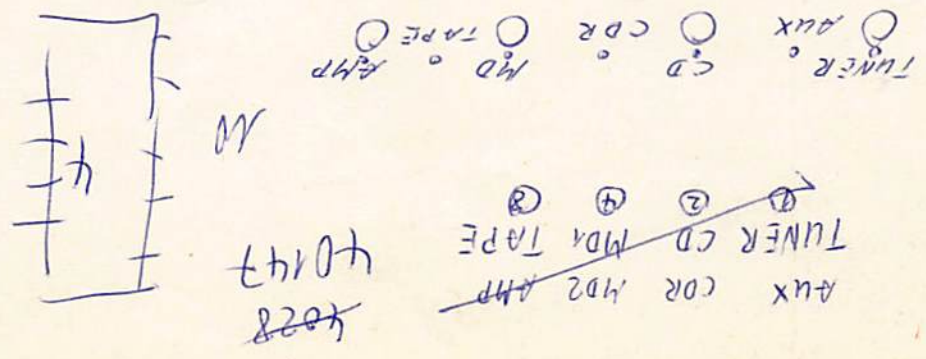

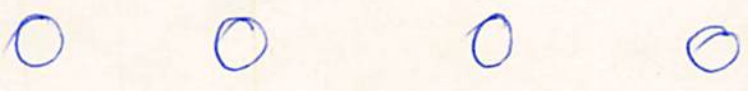
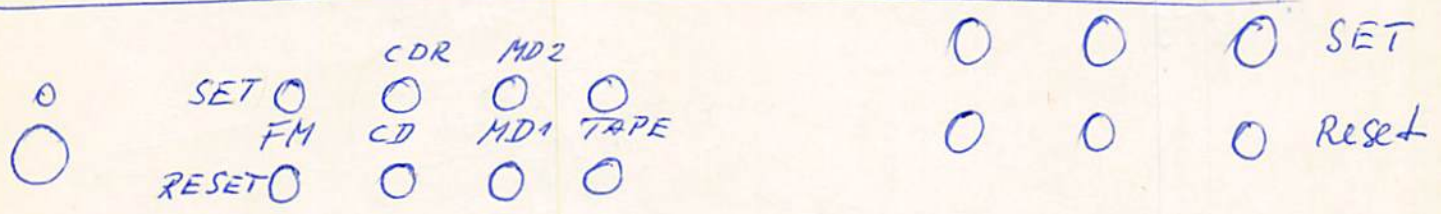
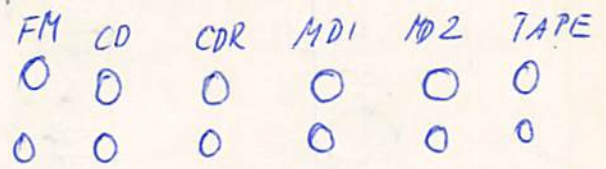
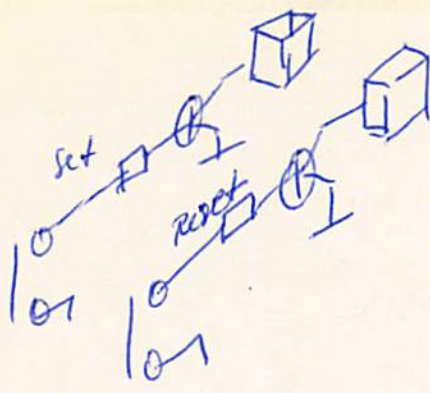

1 Hauptschalter

5 x Netzschalter + 5 x LED

3 x Klinkebüchse (AUX, 2 x KH)

Wahlschalter (4 Quellen Aux, FM, DAB, TV)

Volumen Amp

Volumen KH

1 x LED als Netzkontrolle

NF - Pegel (µA)

|

12V/0,2A

Netzteil f. Relais-Modul + KH Amp + LED

Netzteil f. Amp 12V/2,2A

Steckdosen 2 x Schuko, 2 x Euro, 2 x KGB

Eingang: 1 x KGB St. m. Sicherung Rückwand

Audio In: 3 x 2 Cinch (Rückwand)

In: 1 x Aux (Ø 3,5 mm) Front

Audio Out: 2 x LS' Bü. (Rückwand)

2 x KH (Ø 3,5 mm) Front

Netzschalter, Si-Halter, Kaltgeräte einbaustecker
Netzanzeige LED

Wahl-tasten für Gerätewahl (230V über Relais)
" Anzeige LED mit Transistor Schaltstufe

Rückwärtige Steckdosen „Euro“ x 5

↑
Netzteil für Schaltstufe

→ Lautstärke-Trieb separat

Amplifier für: Line In
TV, FM, DAB+

12V/2A Netzteil für Amp.

Gemeinsame Auswahl

LS-Ausgänge für Boxen

KH für: Line In
TV, FM, DAB+

Netzteil für KH-Amp.

KH-Amplifier mit separatem
Lautstärke-Regler

JBL
175 x 25

55 x 2
5 cm

Wahl-Schaltknopf

Vol. (f. Amp) Knopf

KH Vol. Knopf

} farbl. passend!

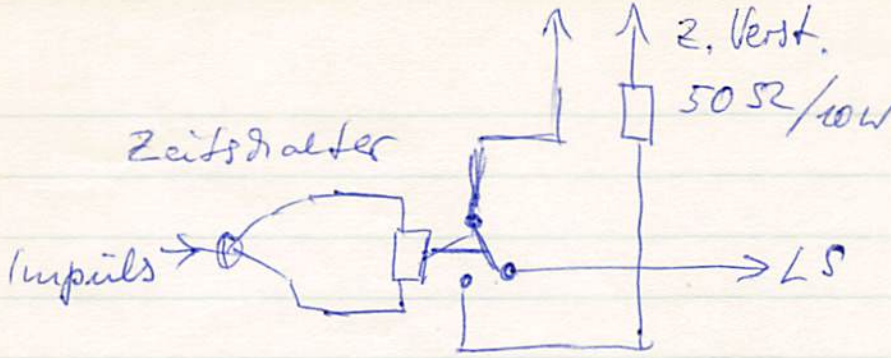

(LS-Schutz-Schaltung)

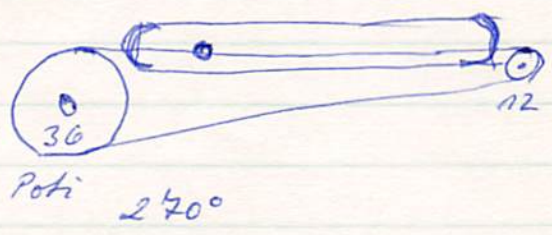

Seilführung

Kol \rightarrow R_{variabel}
 Koppelung eines
 R 's auf gleicher
 Achse in Auswertung
 mittels Meßwertes

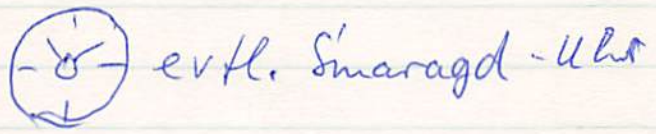

Inkrementalgeber an Poti
 gekoppelt mit Frequenz-
 vervielfacher zur Darstellung
 mittels Schrittmotor

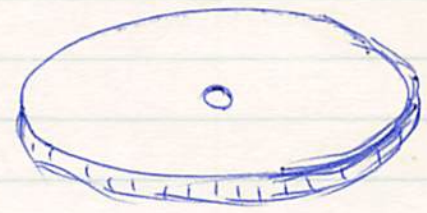

Möbius'sches Band - Poti ca 270°
 (theoretische Anzeige max 540°)

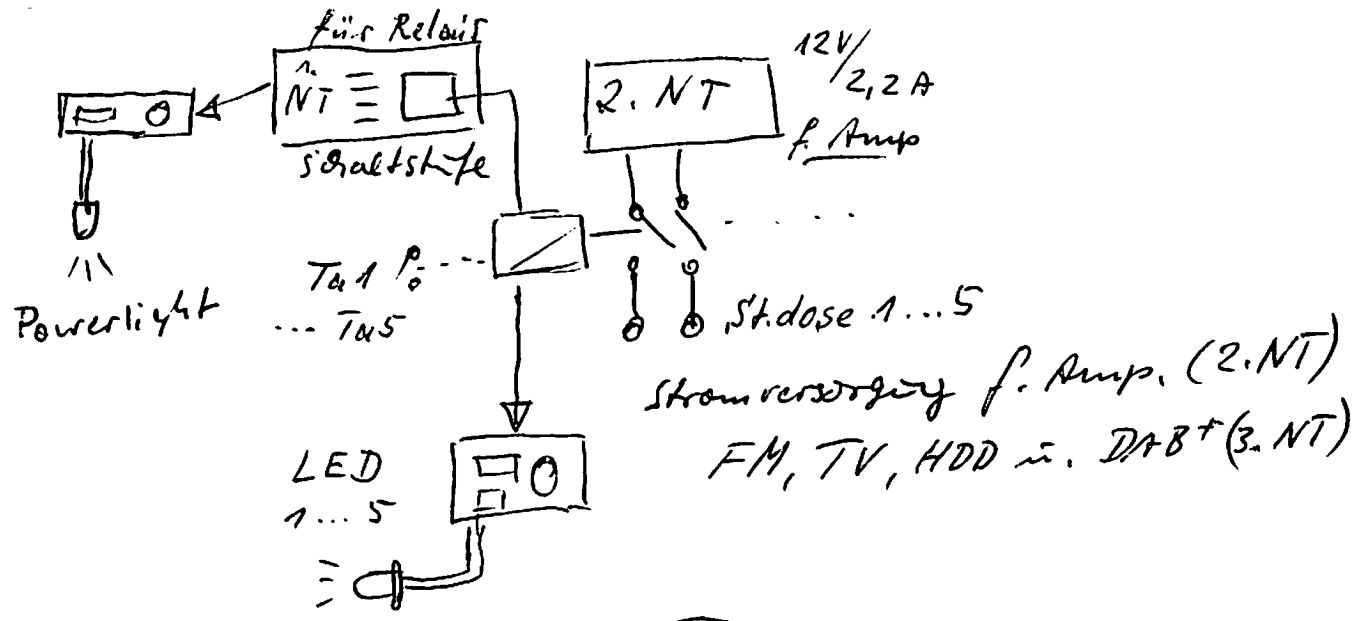

Netz „an“ ^{LS-} & meist Amp.-NT aktiv (NT-LED deaktivieren)
 oder verlagern

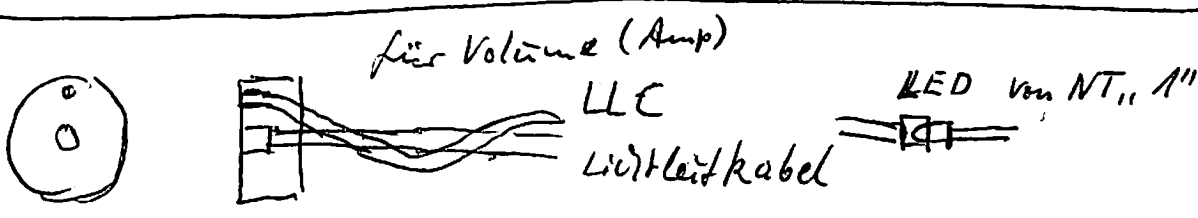
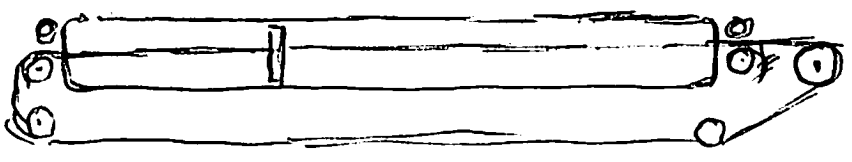

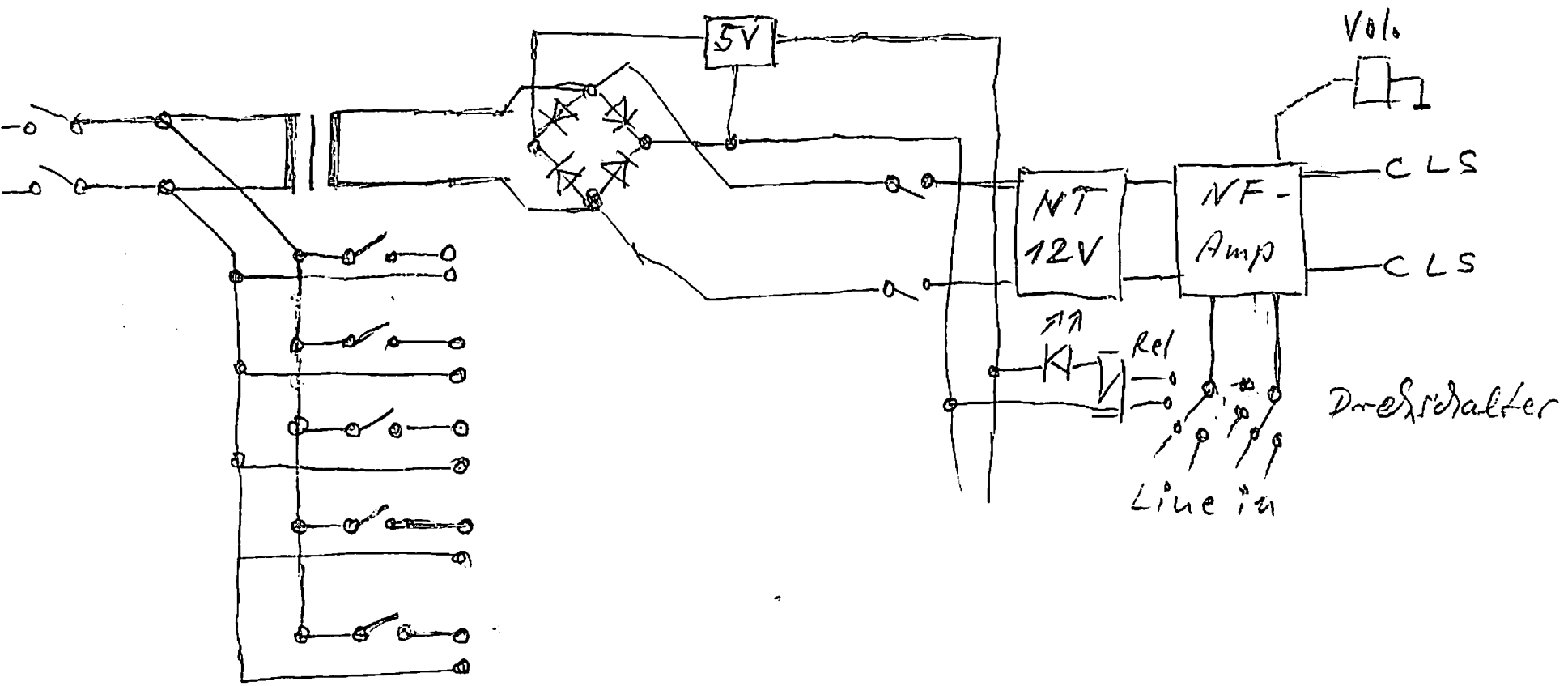

Hauptalter
Ø 6,0

Quellensalter (KH-Bü 3,50)
(KH-Vol. Ø 6,0)

Balance }
Bass } Ø 4,0
Treble }
Vol: Ø 6,0

nicht vorhanden
SPDIF / Analog
30,- Wandler

711 X 419 X 100

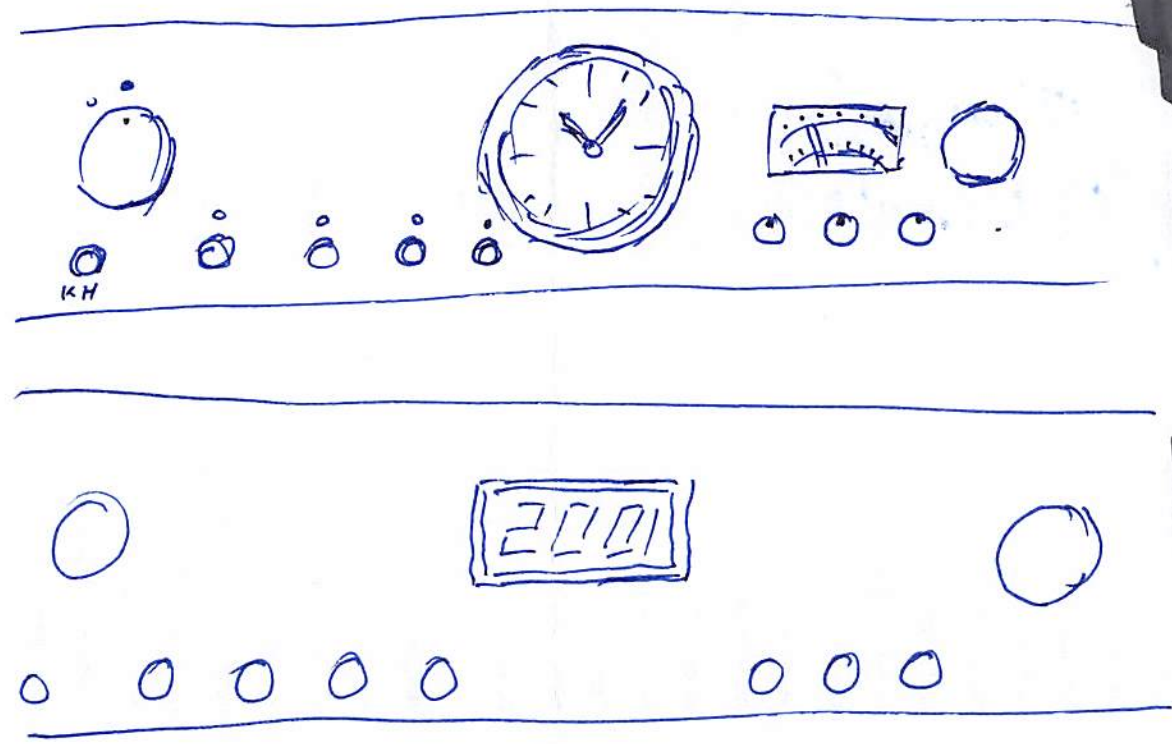

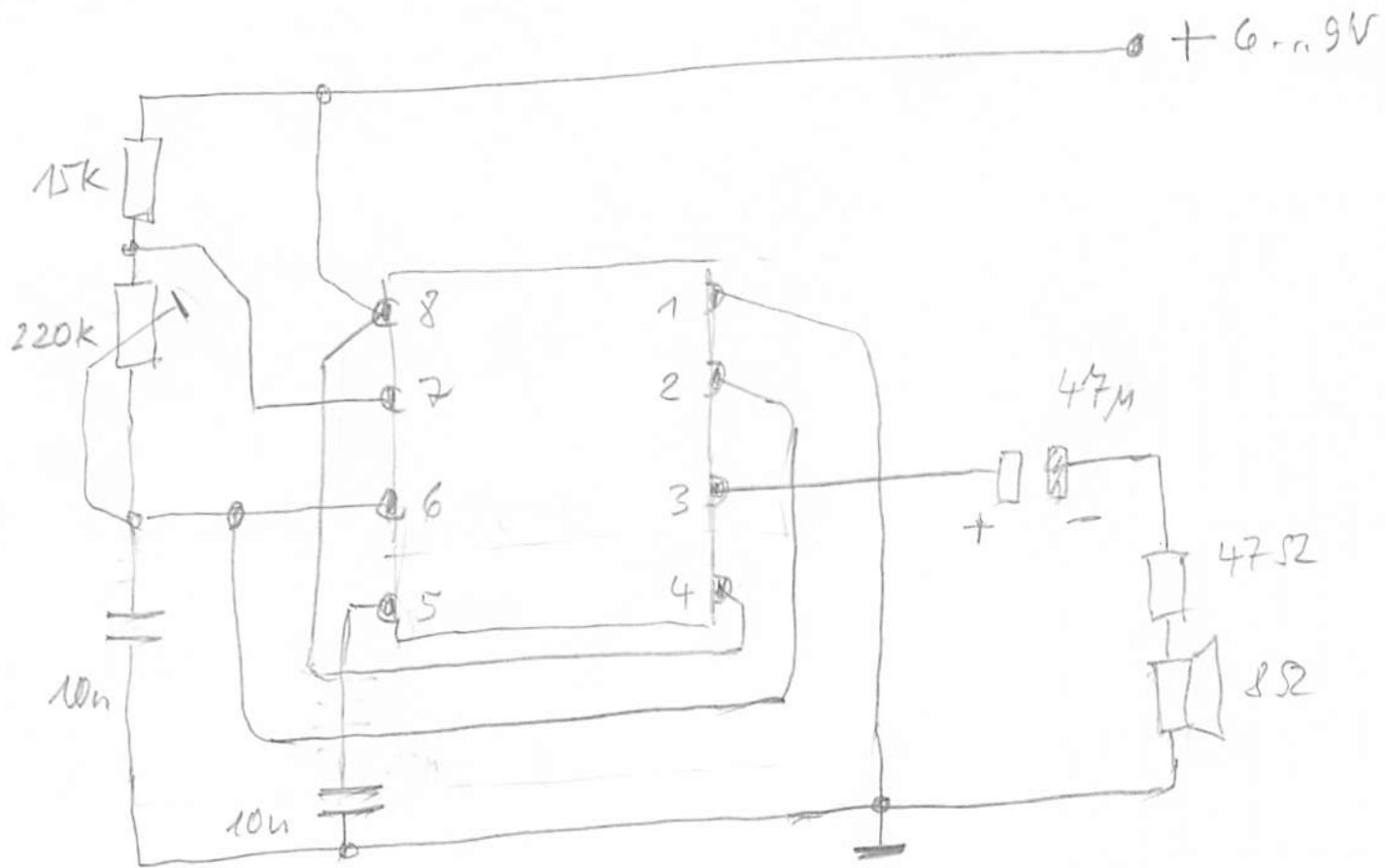

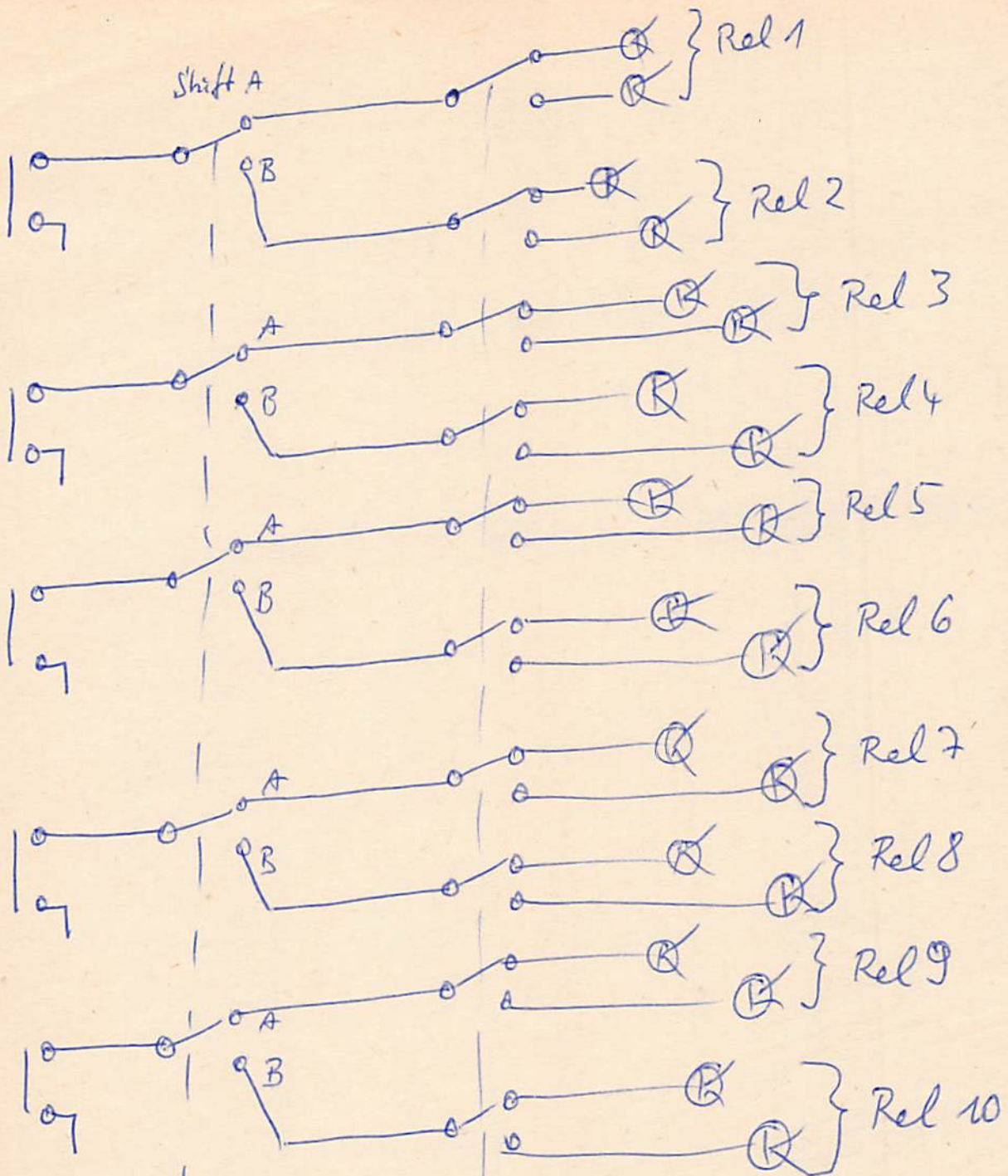

(A oder B)
Shift

Stocker Reset

Sie fern ~ Radio.
0190 5747

RX TB TA VCR CD

Radio Treff Nr. 47

Radiovoja - Info

Tag / Zeit / Freq. Digit 4



K45

Ralf Holm

fm Spezial

MW

NL

Veronica 828 kHz

1035 "

1224 "

15⁰⁰ → 7355 kHz

Georgia - N 6 TV

Fr. - 50'

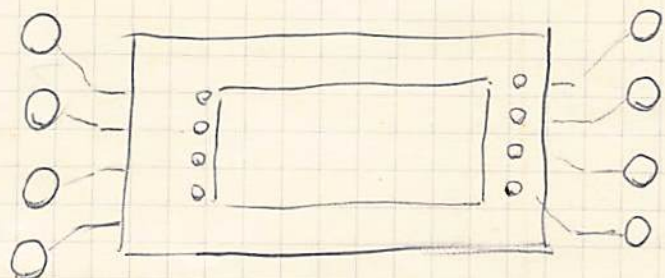
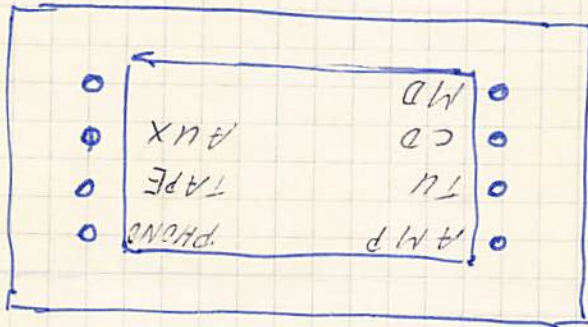

TB — in-out 1
 (VCR — in-out)
 CDW — out
 MD — in-out 2
 CD — out
 AMP — immer
 TU — out
 AUX — in-out 3

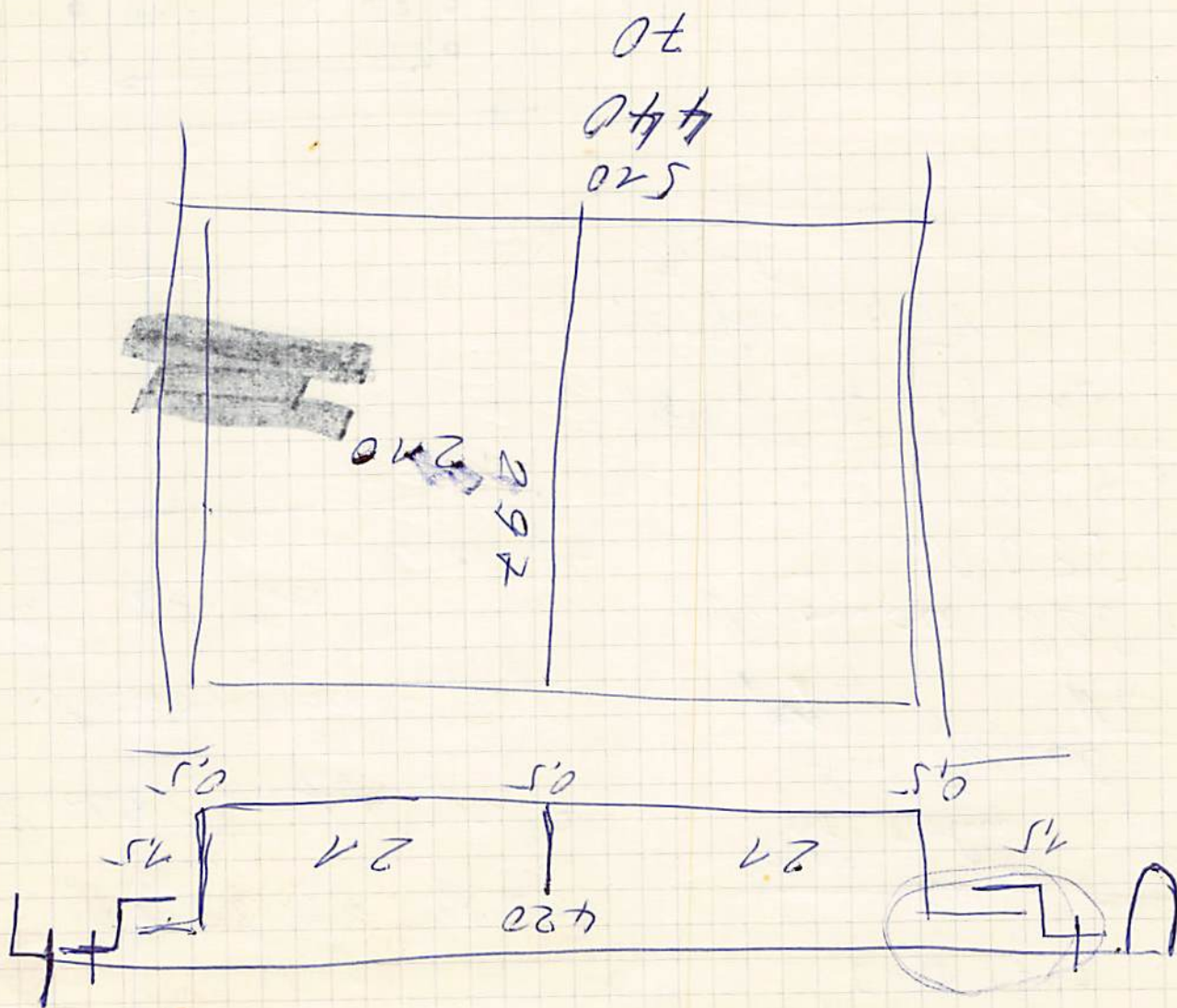
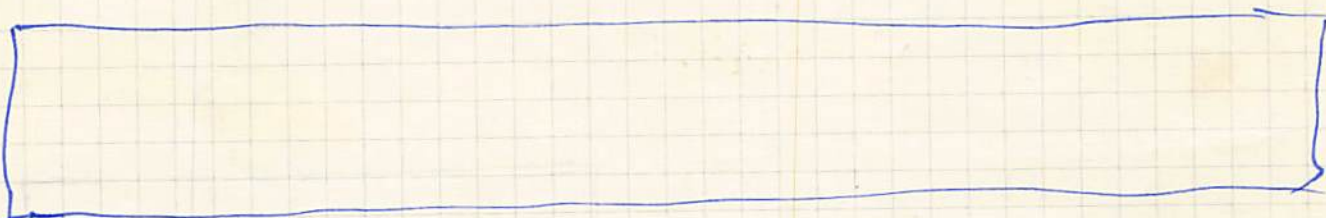

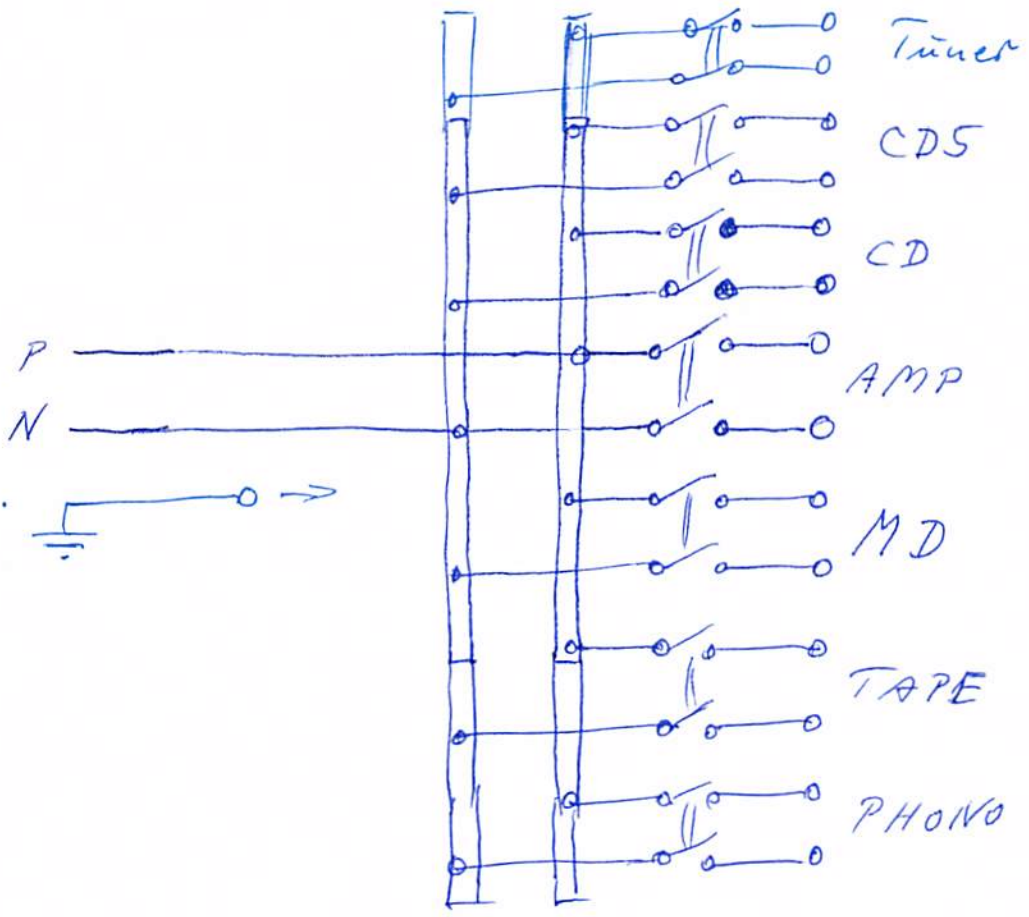

Eingang: FM, DAB, TV, HDD, BD/DVD Ausgang: Cinema in Lautspr. (12xClou)
 -AUX

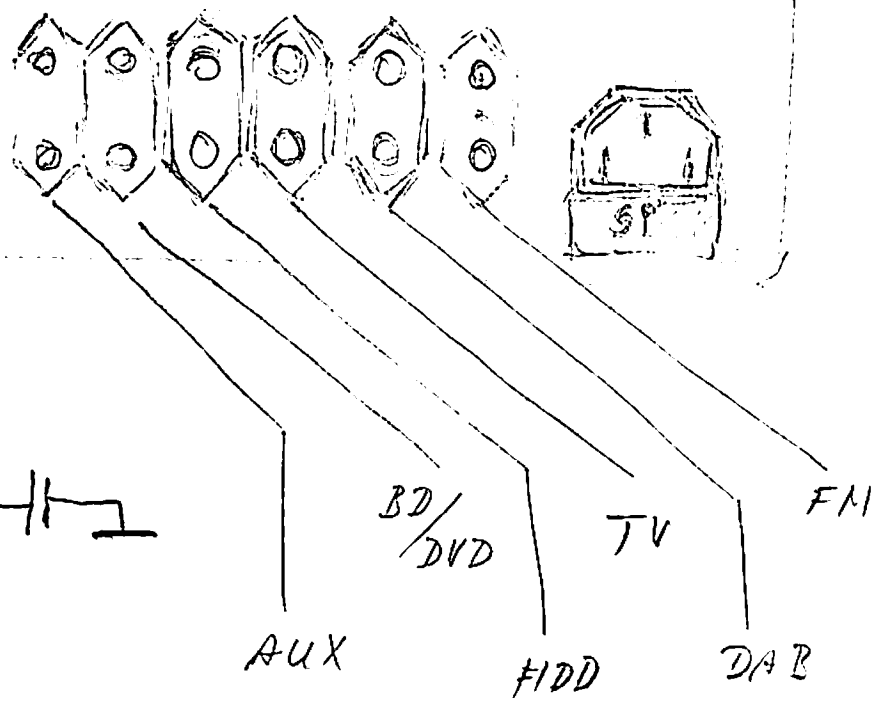
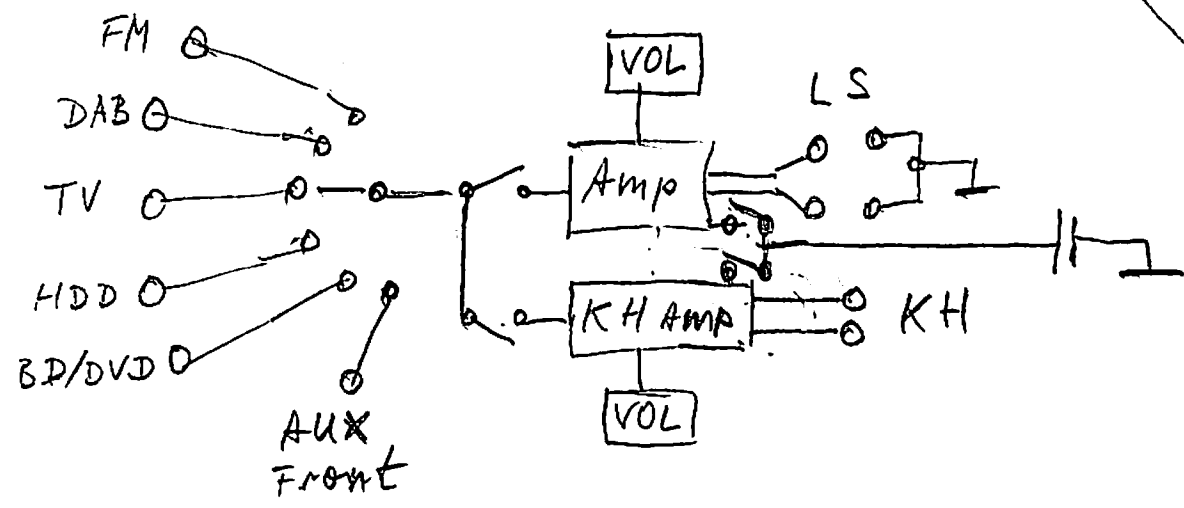
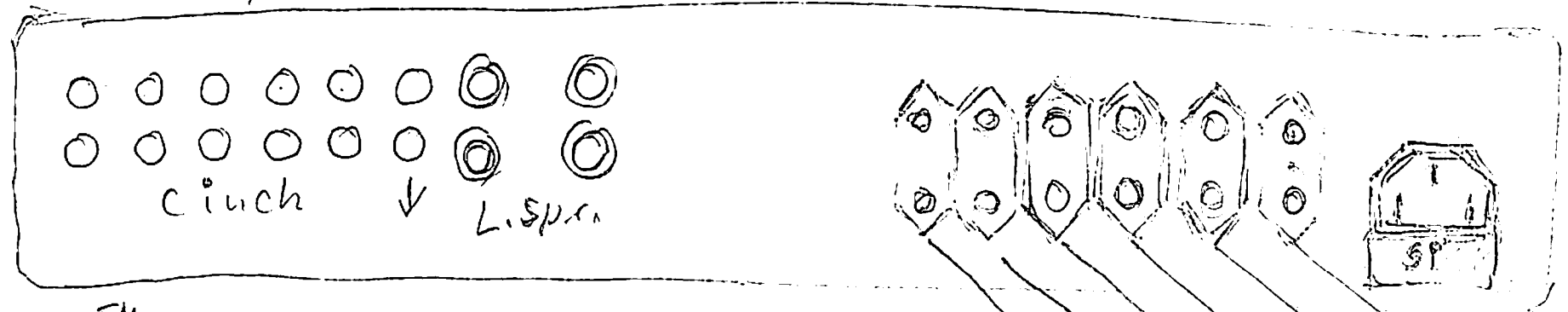

1 Podmini 3

1840
 2-2-2



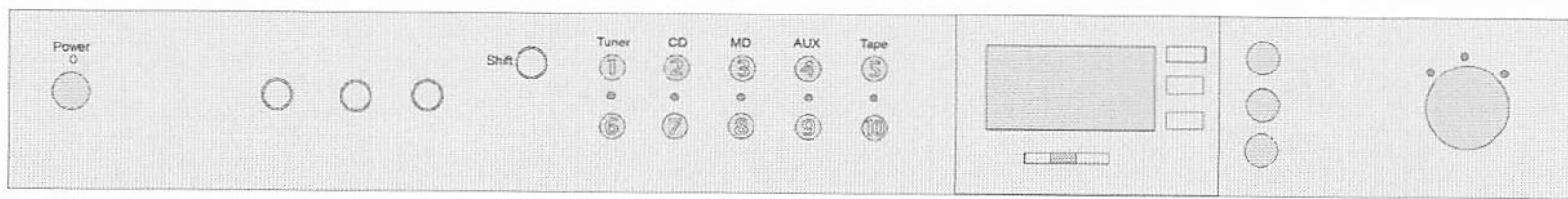



↑
Dugena





Microsoft Works

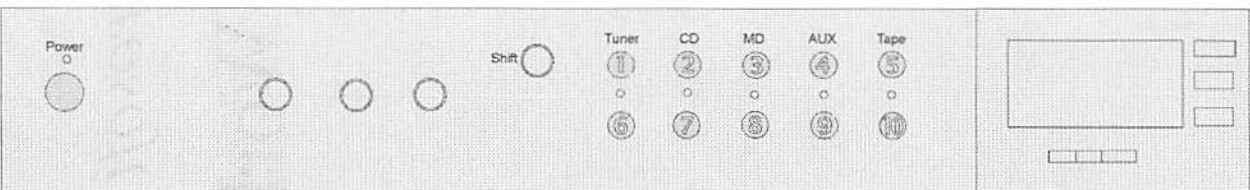

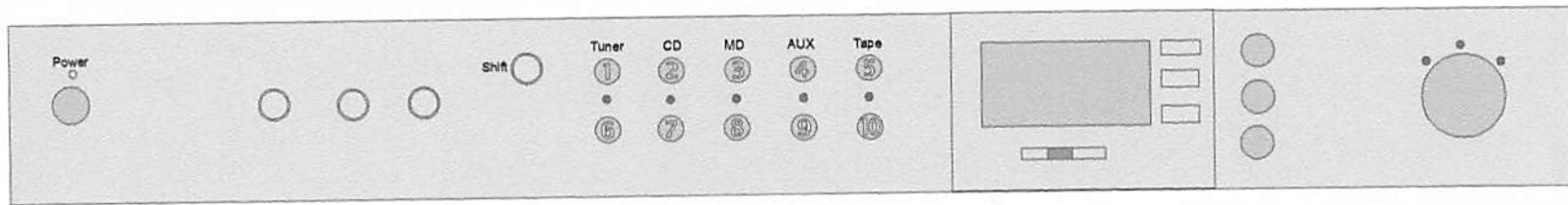

Kaltgerätestecker
+ Si

7x Schr-ko - Dose

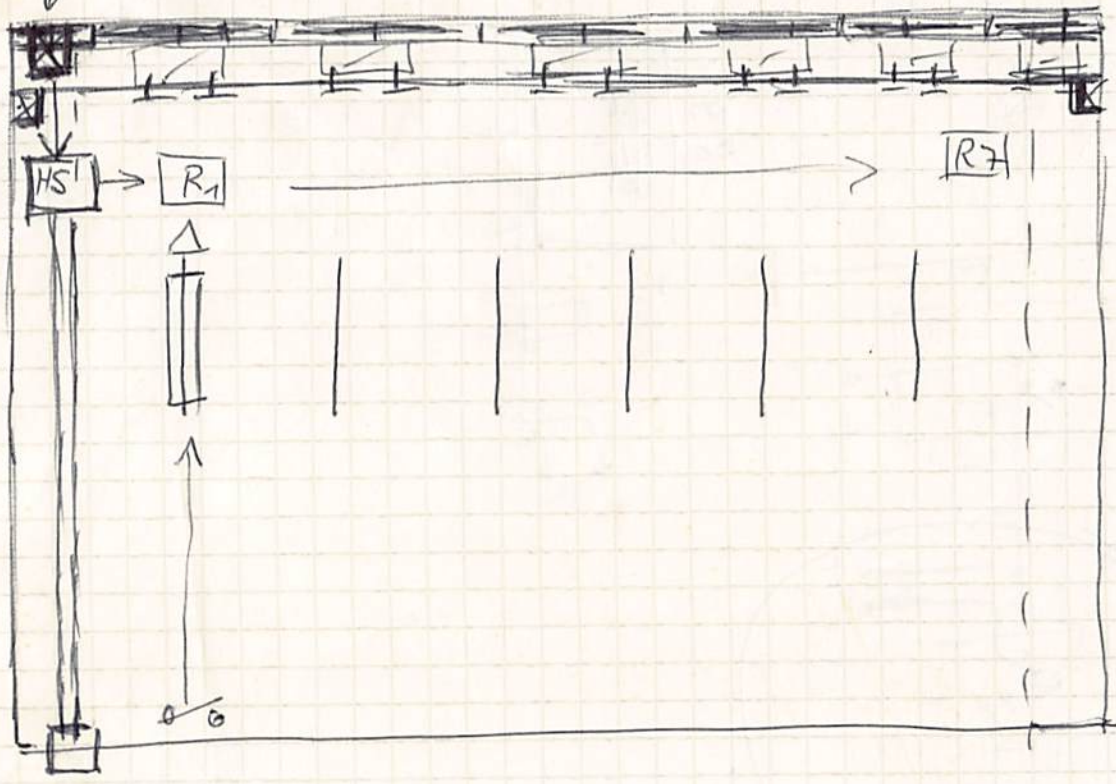

385
45

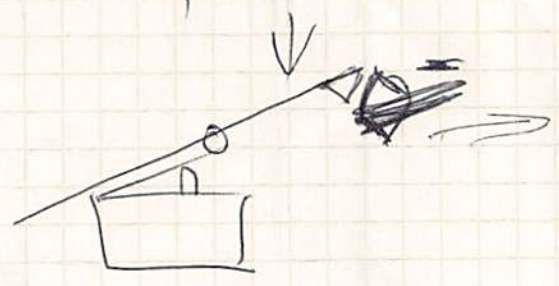

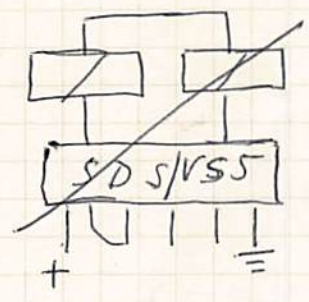
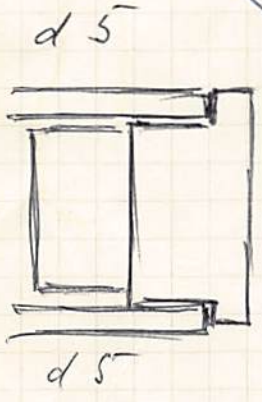
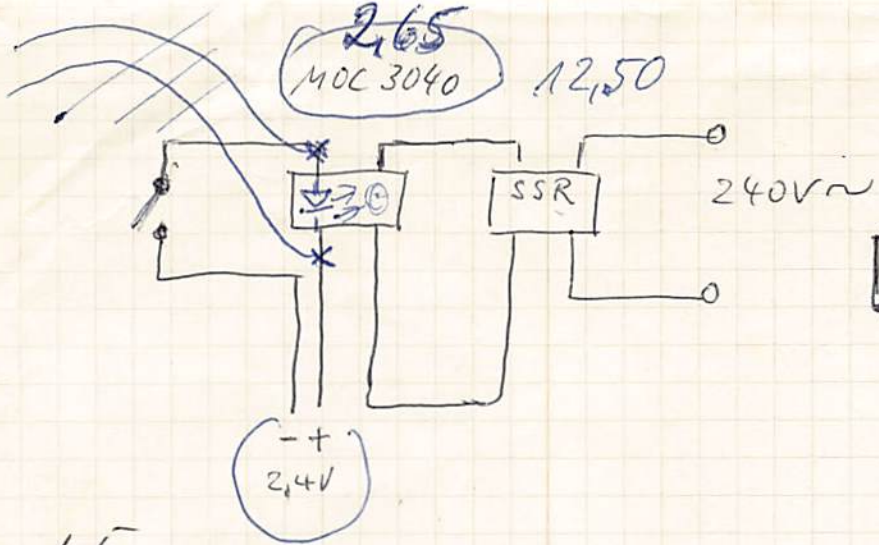

23x 98x 62

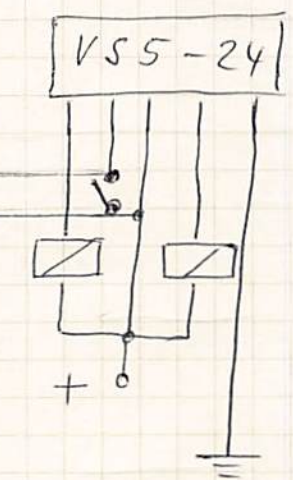
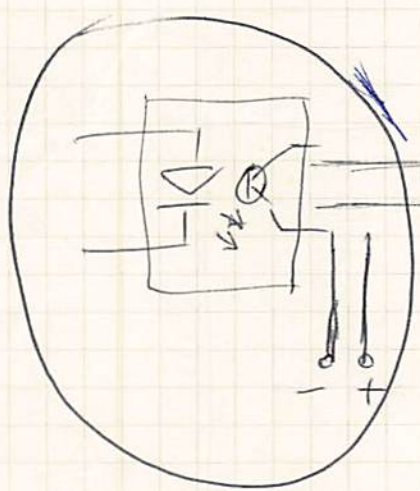

Bistabiles
Relais

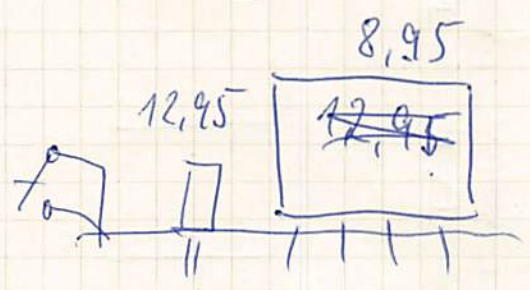
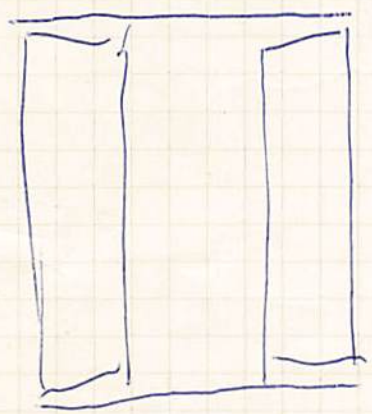

2000

Halle Markier

DABT
Aux | TV

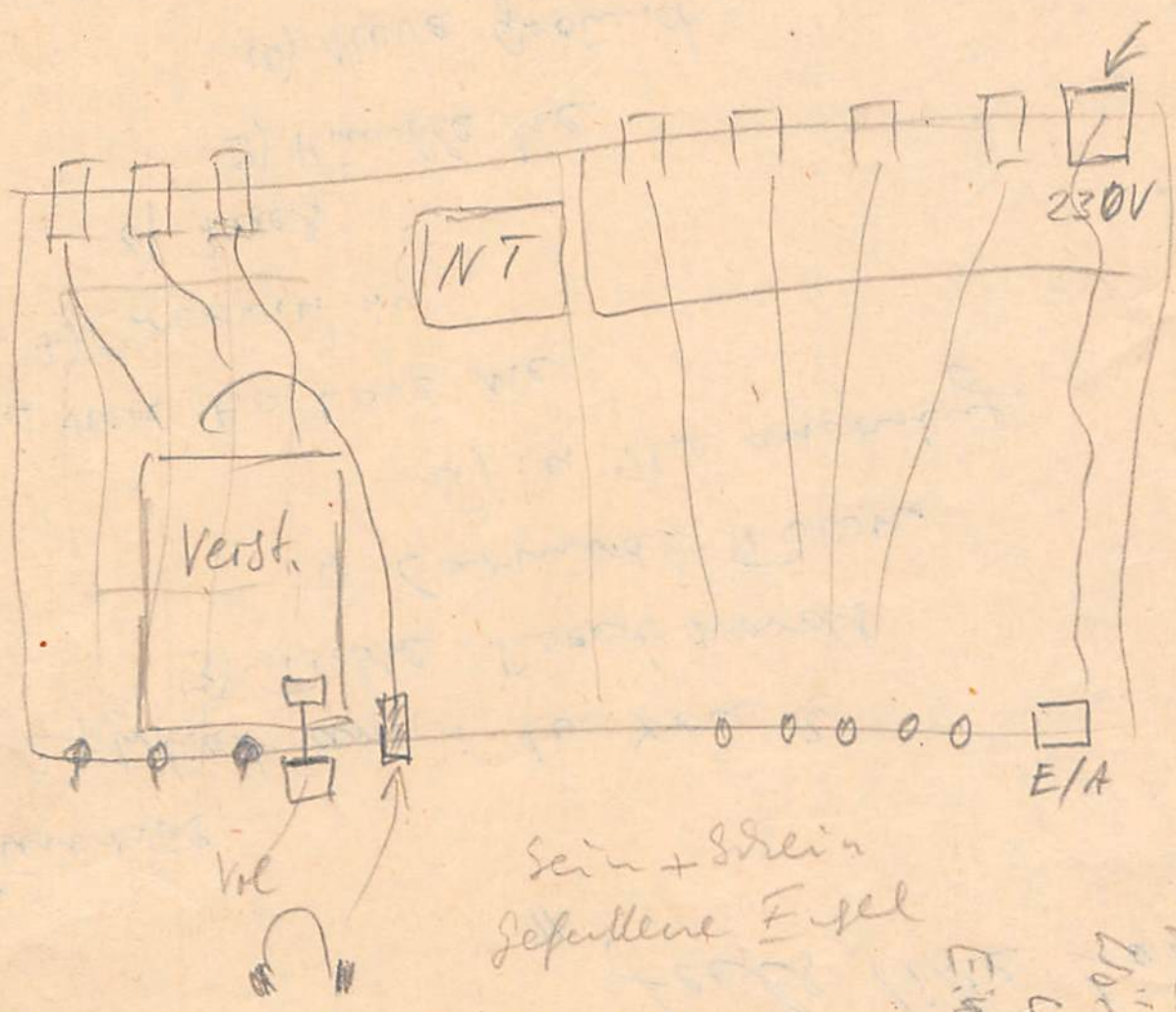
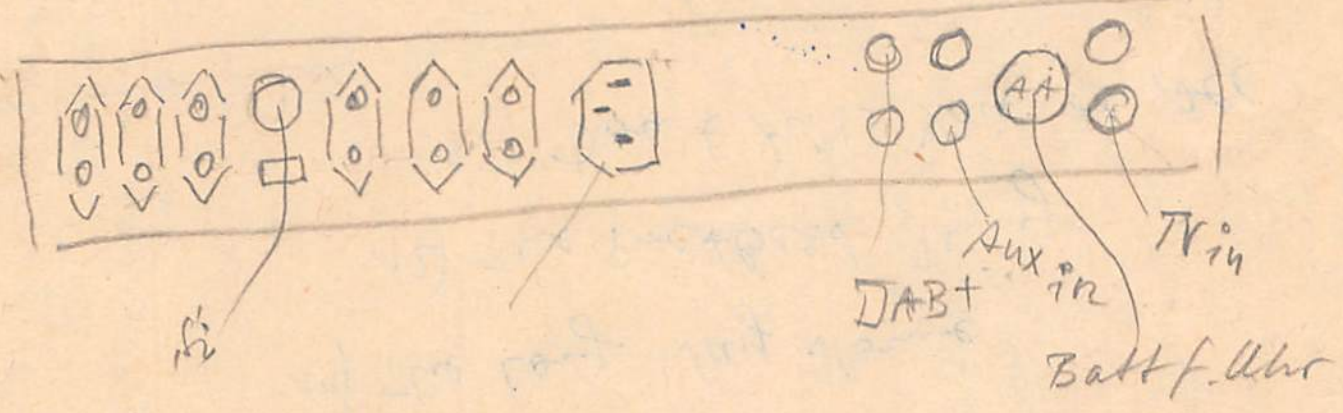
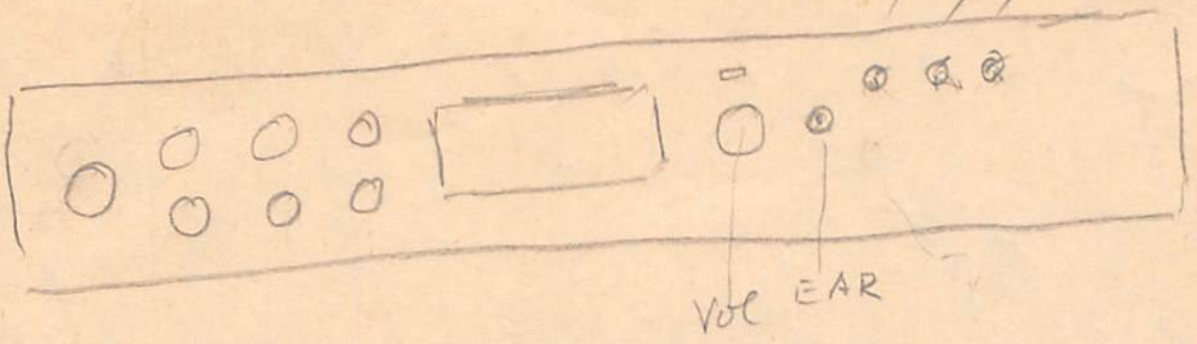

R
Anreise Do 22:30
Fr. 20:15

Klagen für
10er Klasse
4.20
Eintritt

3 oder 2 unter



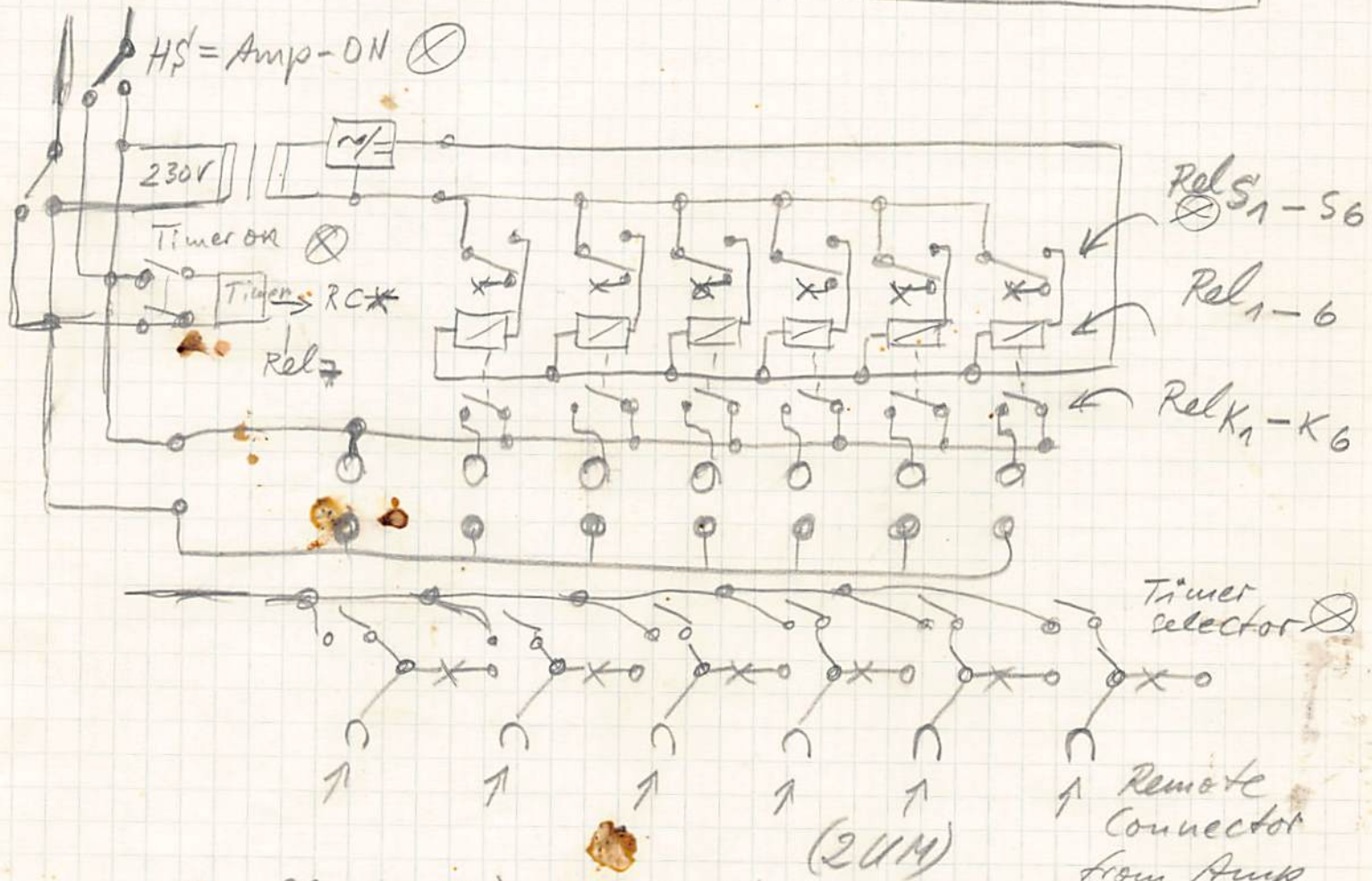
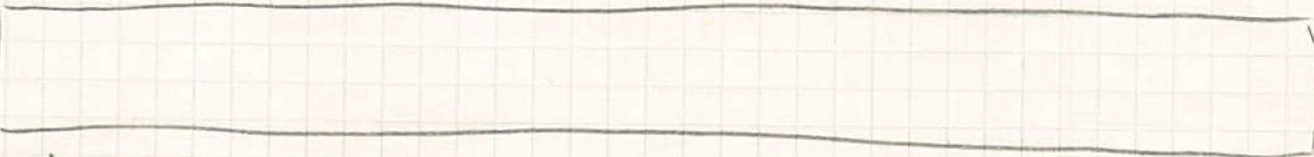
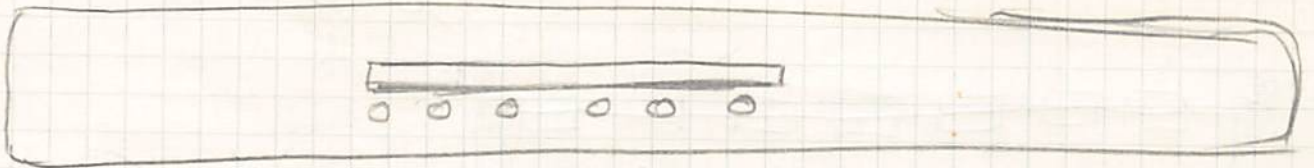

- HS - (Amp ON) — Schalter E/A 250V/5A ~
- Timer ON — Schalter E/A " / 5A ~
- Quellenwahl (Rel_{S1-56}) E/A 100V/3A
- Timer Bedienung

KG-Bu

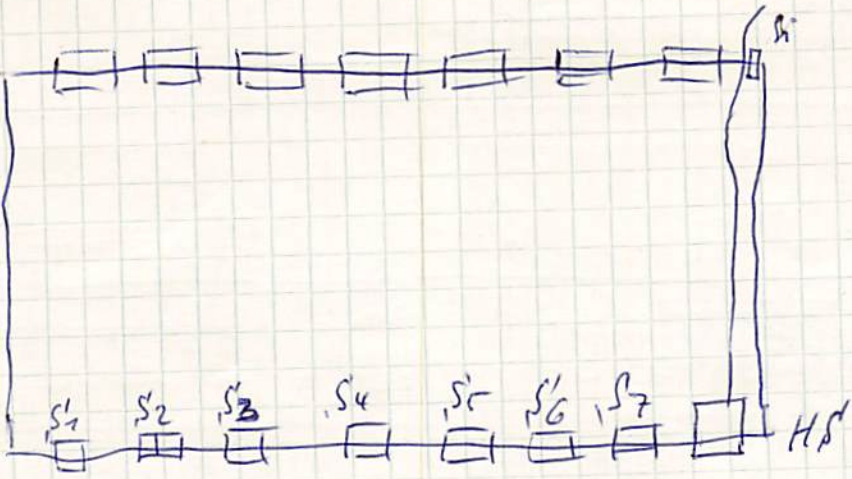

NST.

S8

S1

S2

S3

S4

S5

S6

S7

Hd

1 2 3 4 5 6 7 8
Recorder / TV / Amp. / Media Player / HDD^{NT} / RX / AUX / LED Light

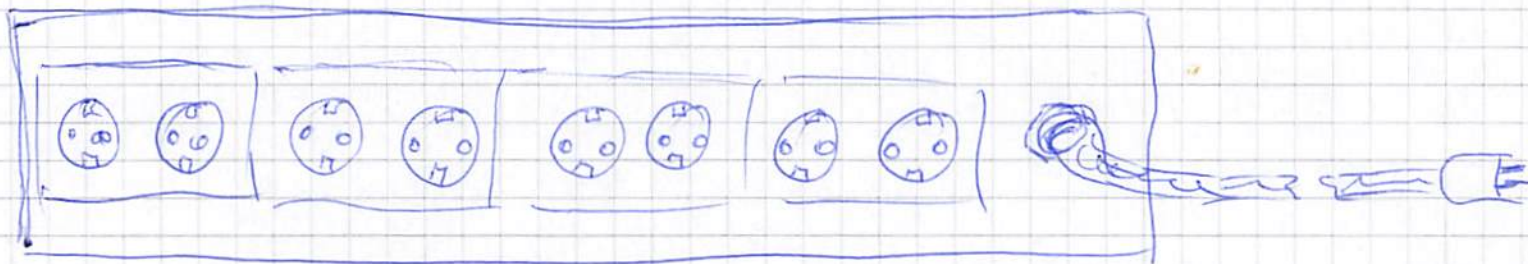
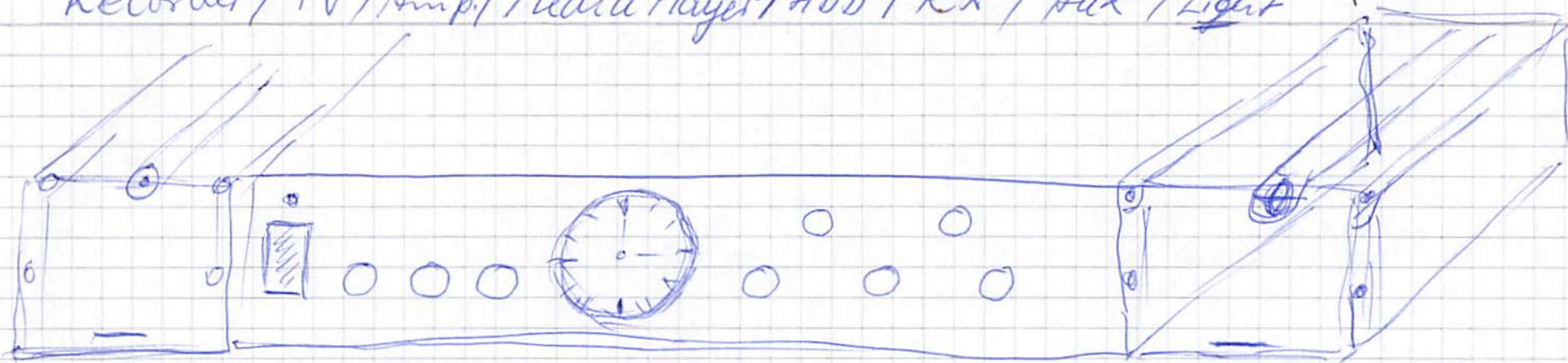

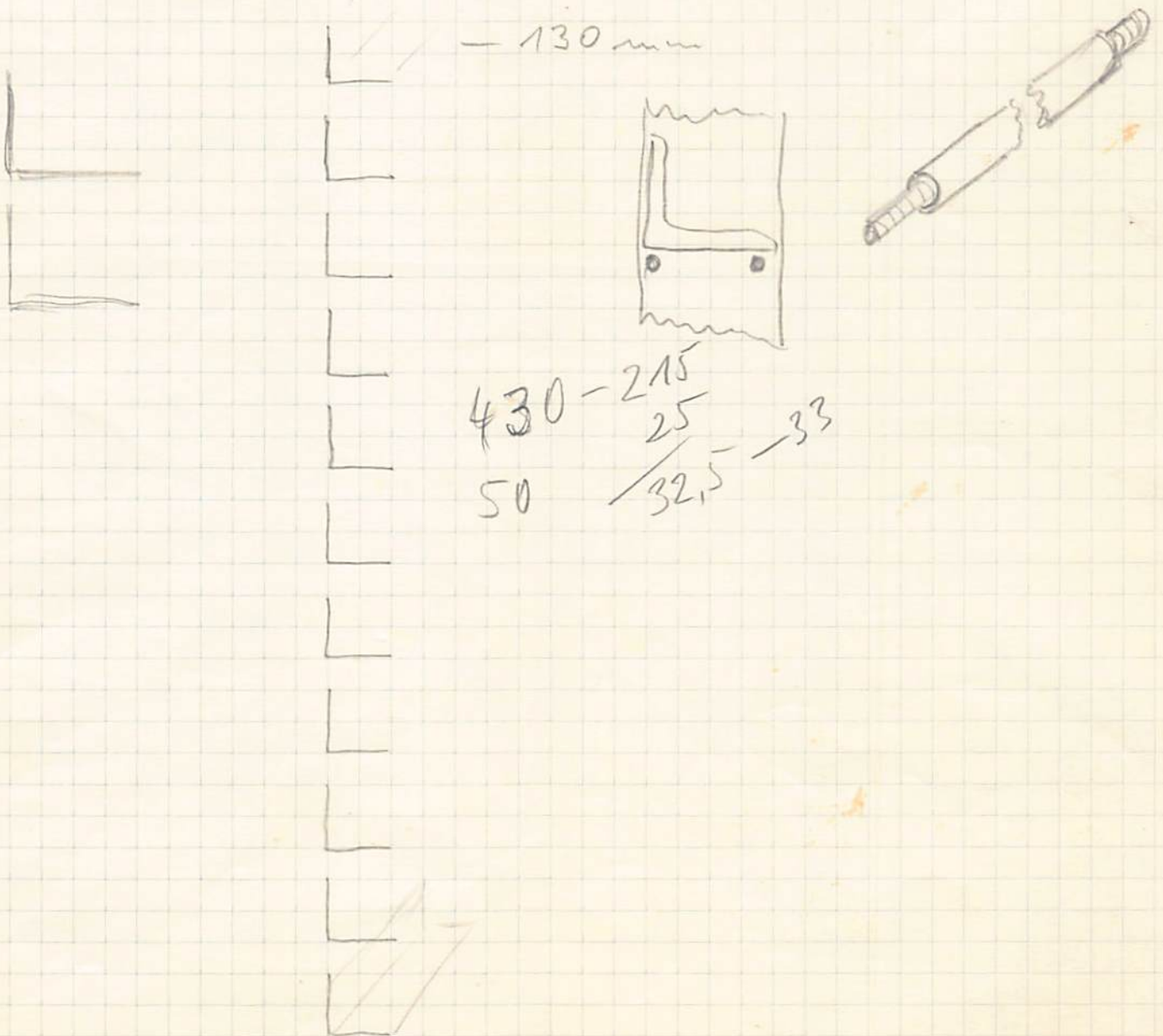
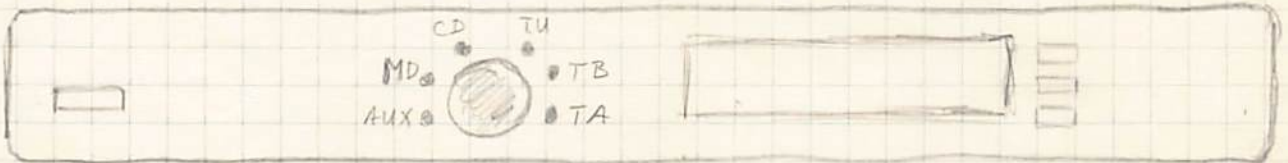
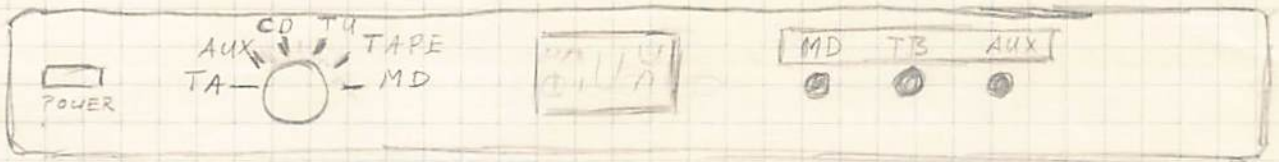

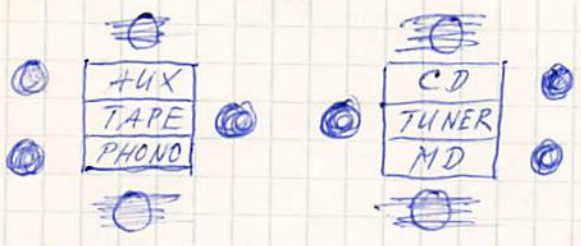
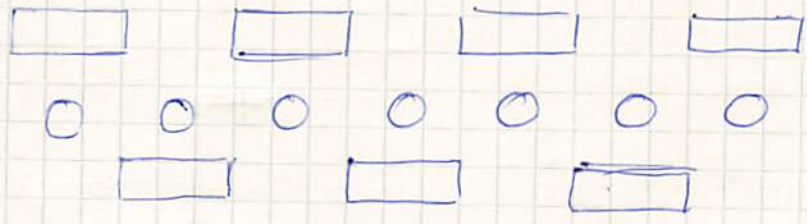
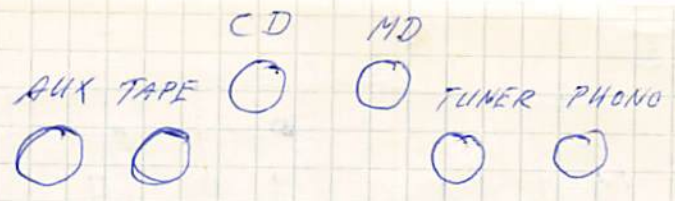
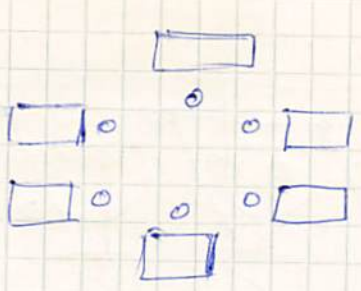

230V

N

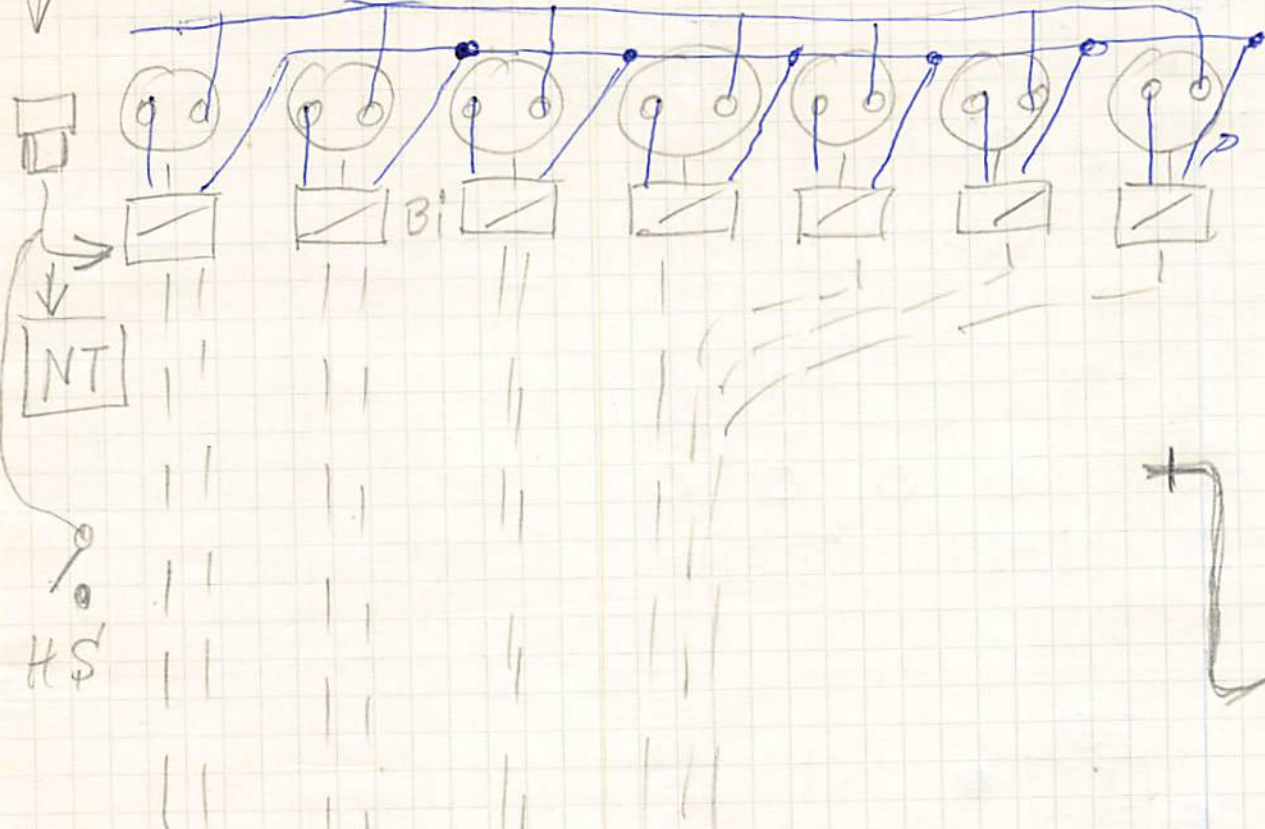

NT

B1

HS

Ta1 Ta2

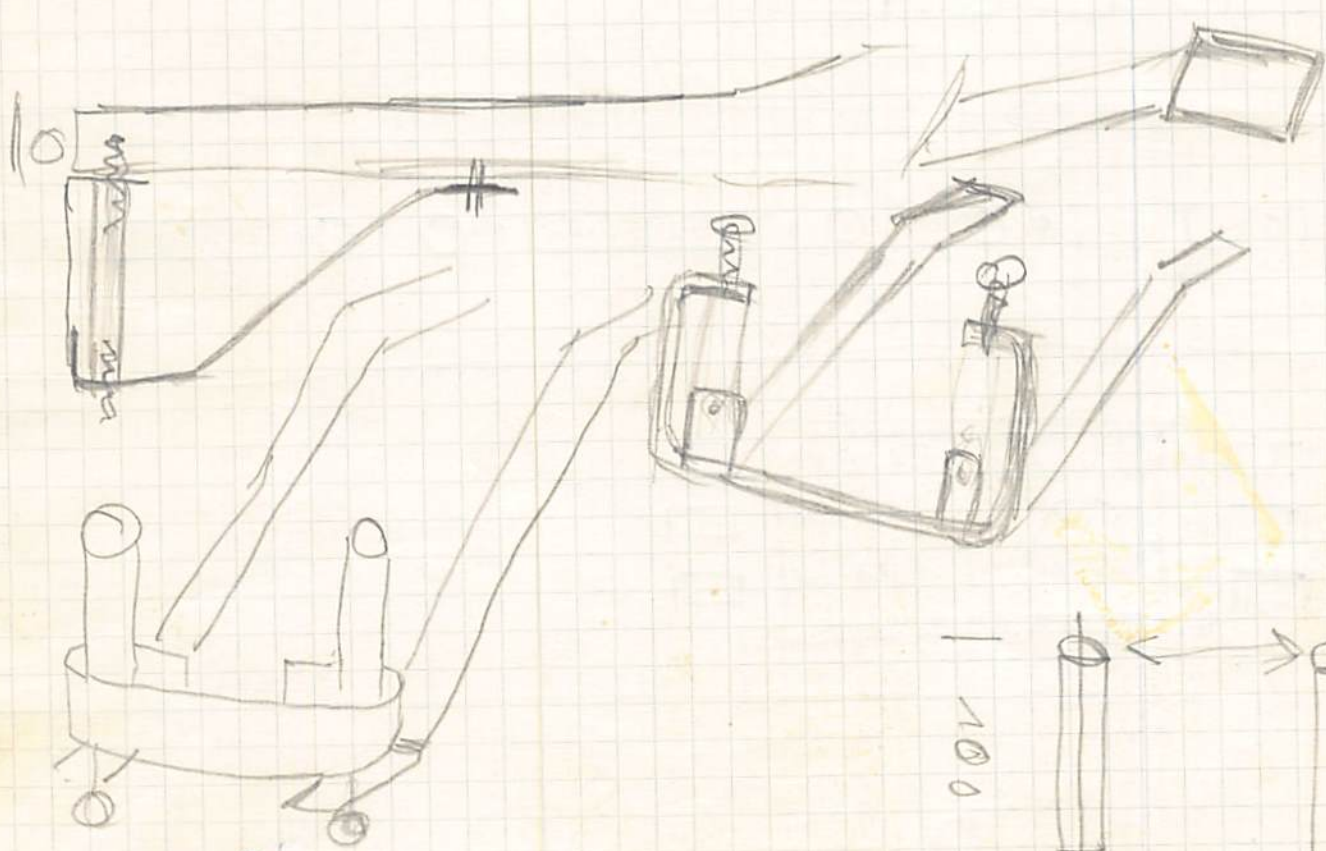

100

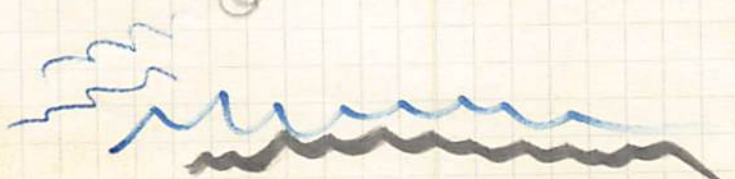

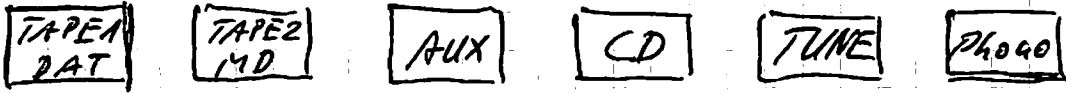
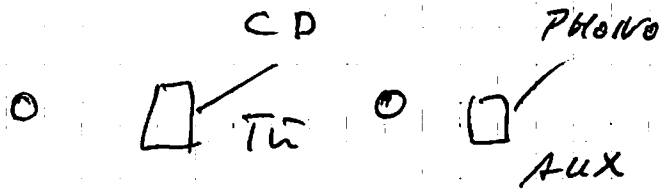

0 0 0
 0 0 1
 0 1 0
 0 1 1
 1 0 0
 1 0 1
 1 1 0
 1 1 1
 ↑ ↑ ↑
 4 2 1

TAPE 1 MD AUX CD TUNE PHONO

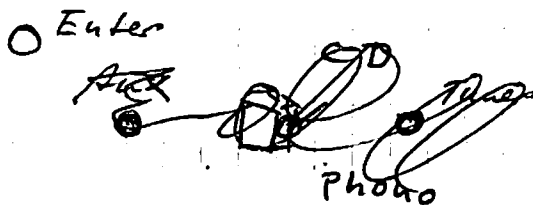
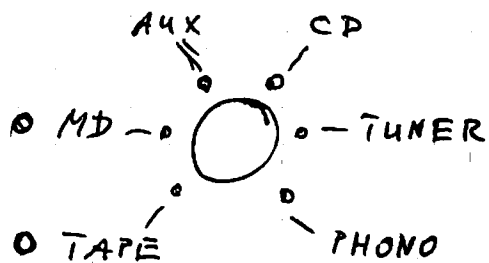
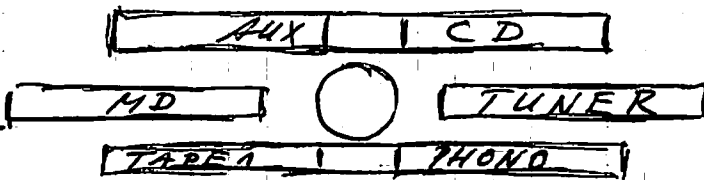
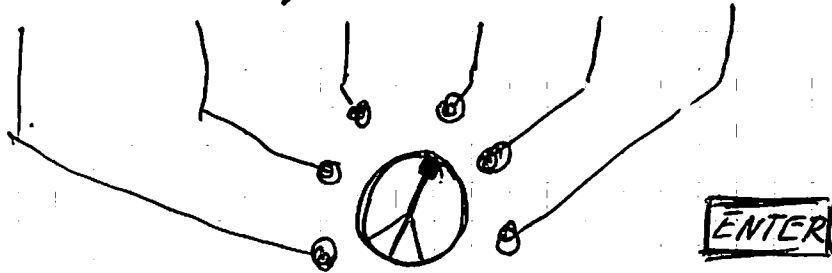

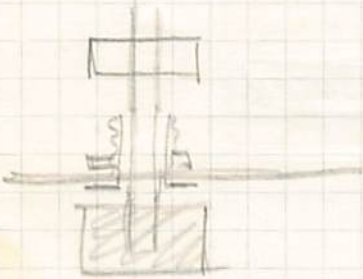
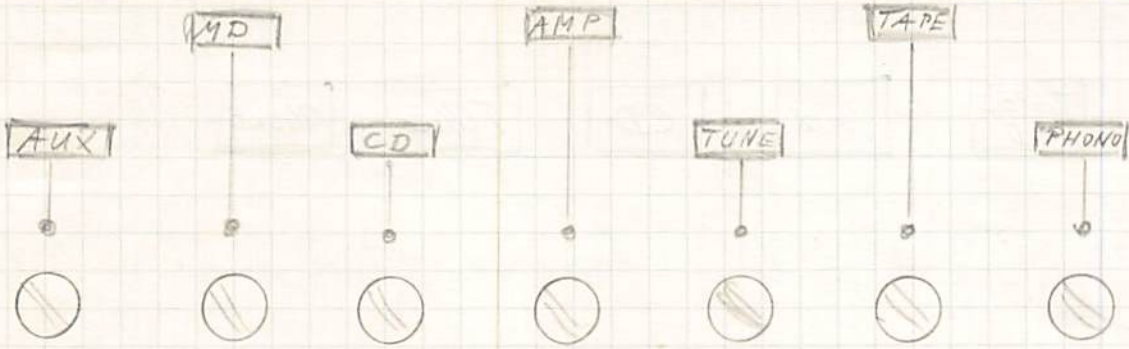

AUX TAPE CD TUNER MD PHONO



POWER



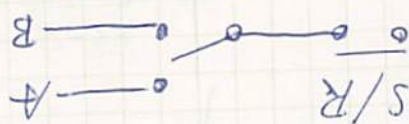
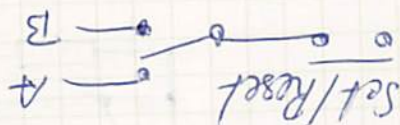
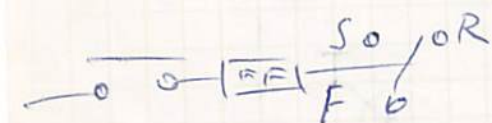
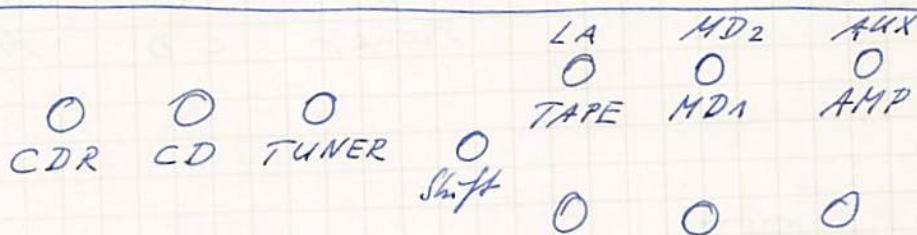
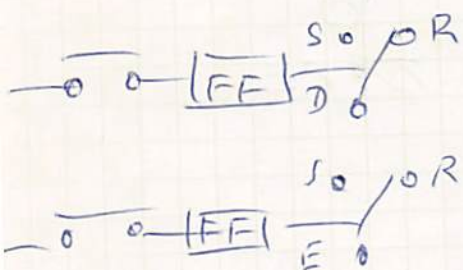
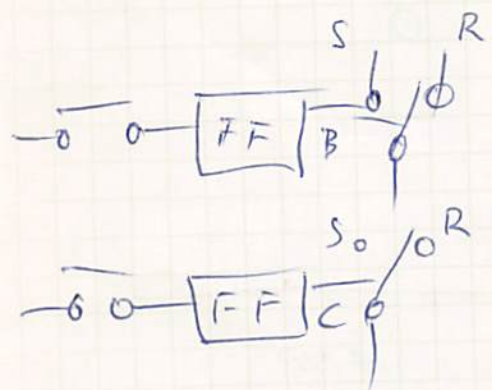
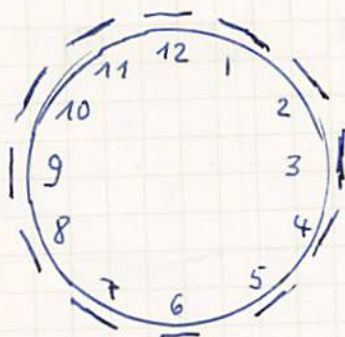
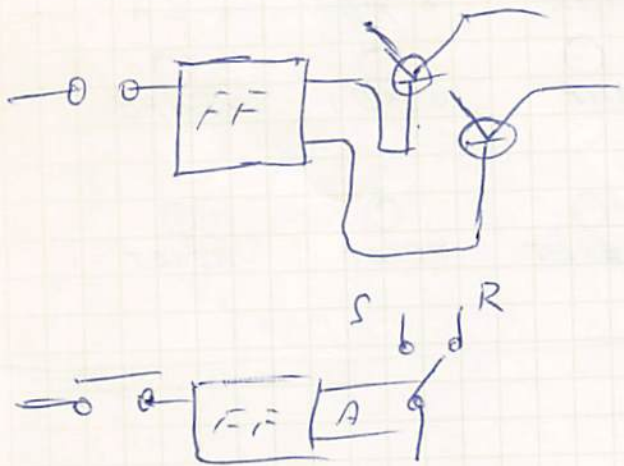

TUNER 13W

CDP 17W

MD 22W

MD 930 18W

CDR 15W

TAPE 28W

AMP < 200W

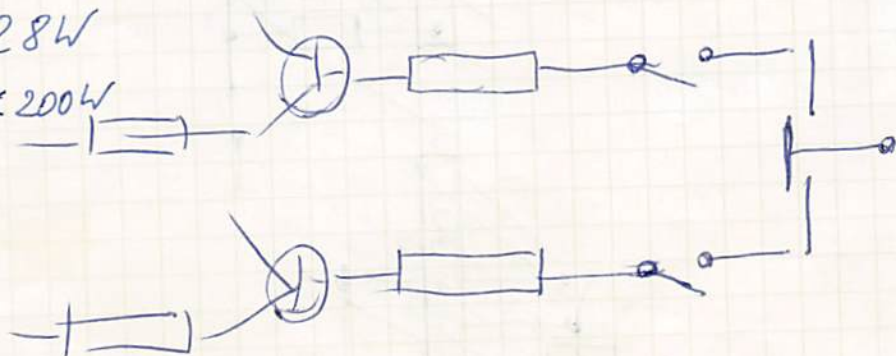

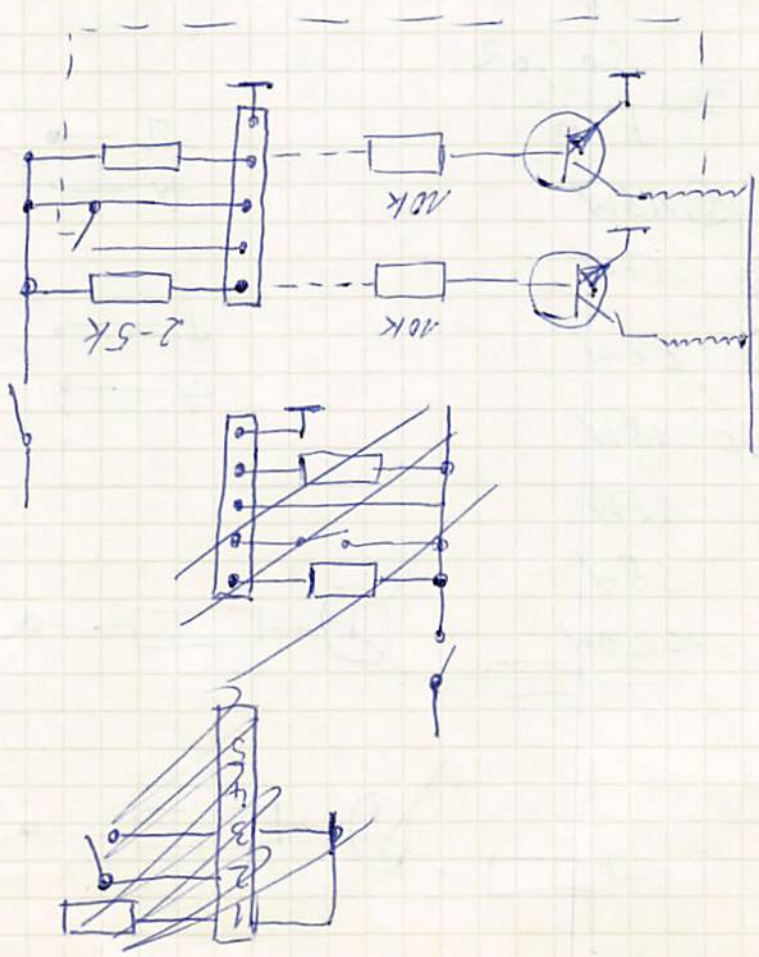
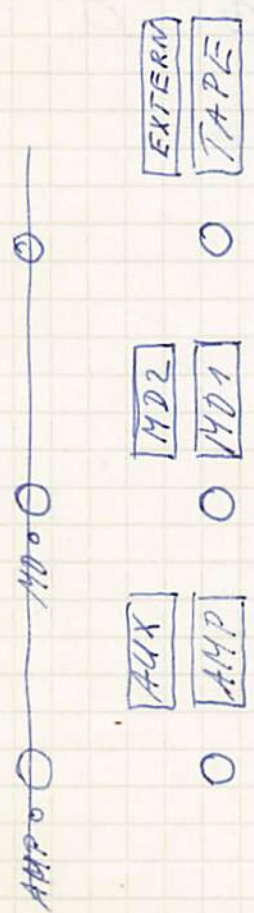
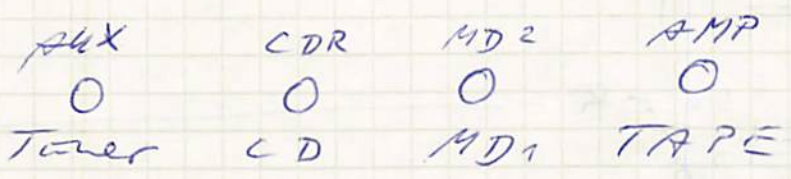
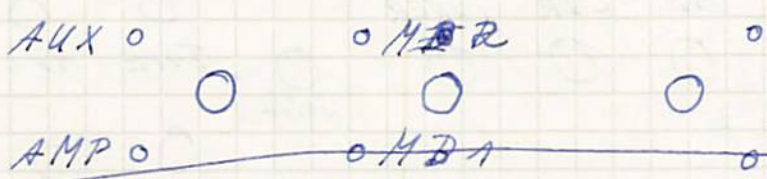

S1 Hauptstrahler
 S2 Wdhlsstrahler Normal / Timer
 R1 Timer
 Ta1 Time
 Ta0 Res

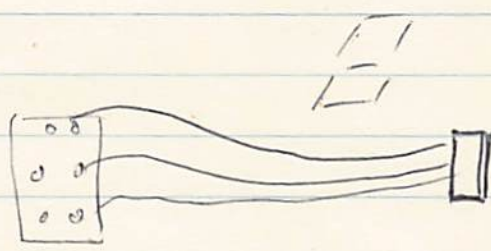
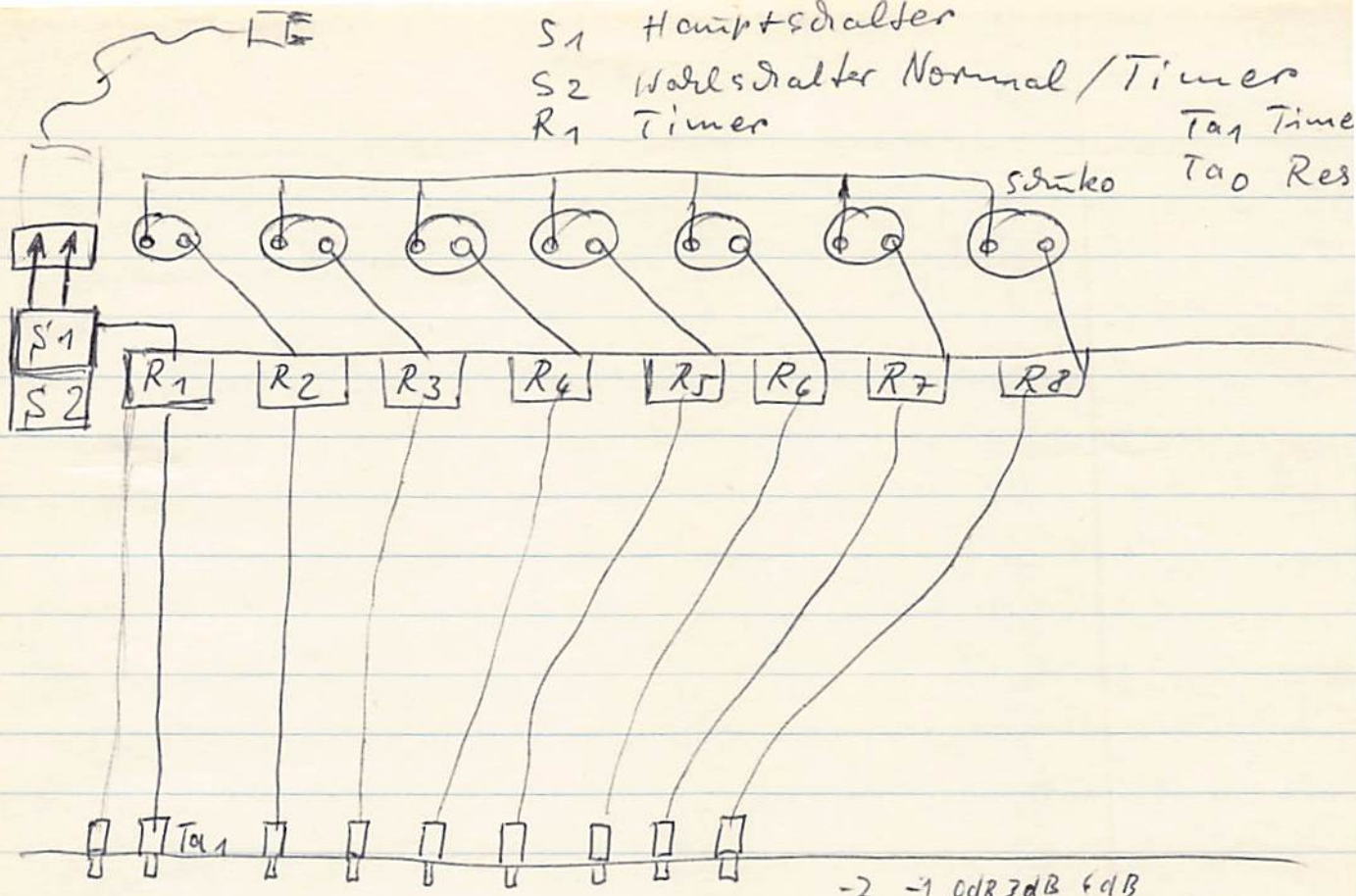

AMPLIFIER
 TUNER
 PHONO
 CD
 MD
 TAPE

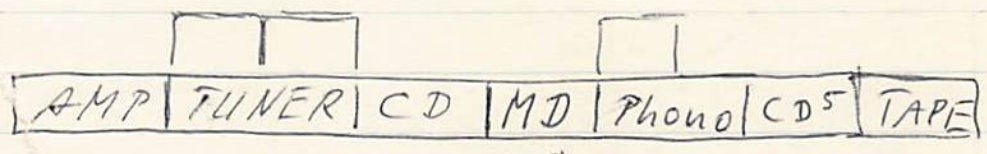

(COS)

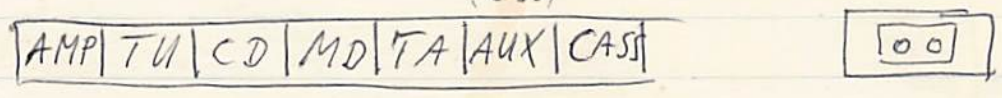

Perestaltik Puzupe

sim

dominantes
eile, 300k
USB

Aux am Front

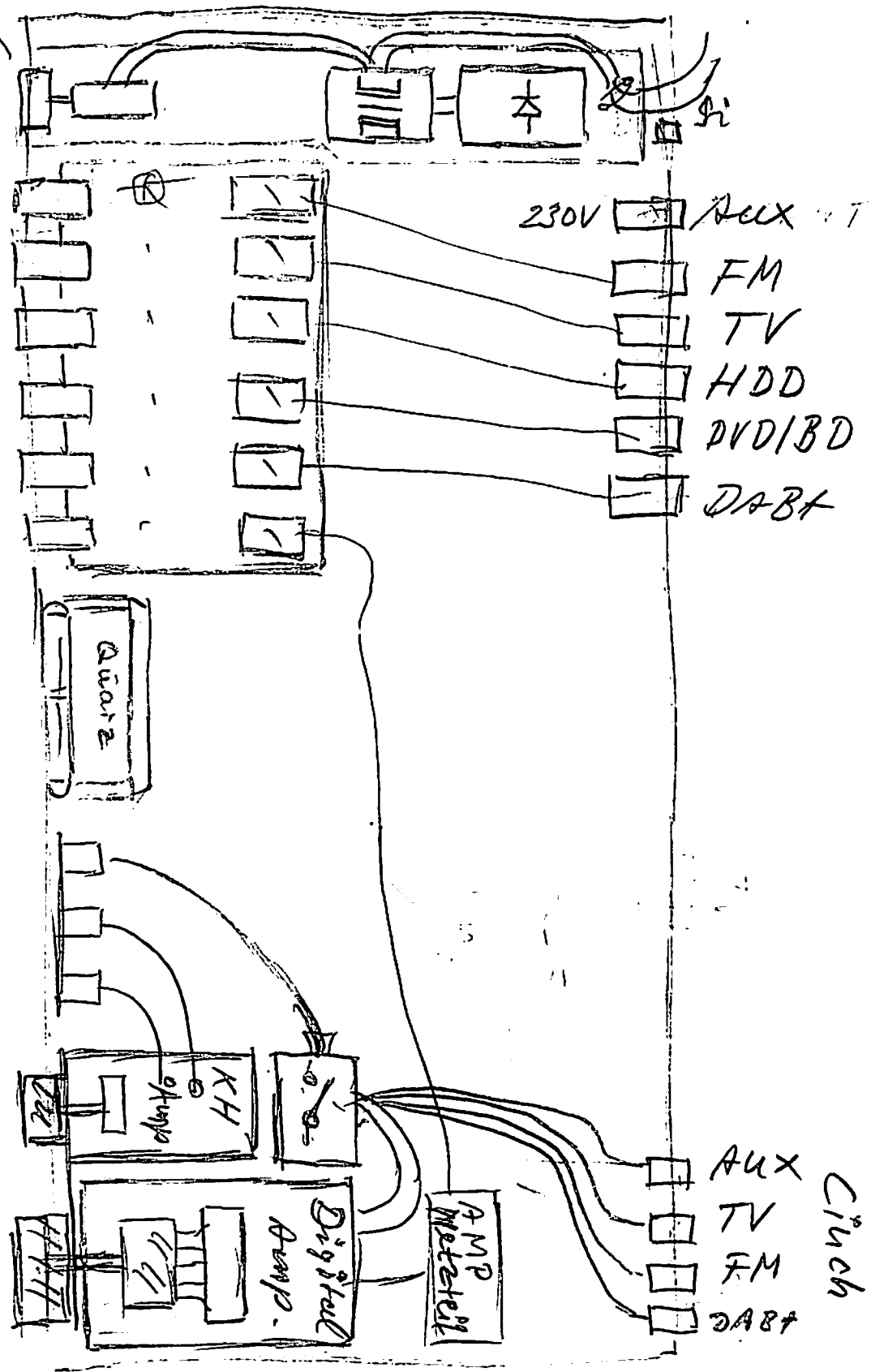

- 230V [] AUX
- [] FM
- [] TV
- [] HDD
- [] DVD/BD
- [] DAB+

- AUX
 - TV
 - FM
 - DAB+
- Cinch

50x

FM DAB TV DVD HDD

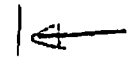

ca 25cm

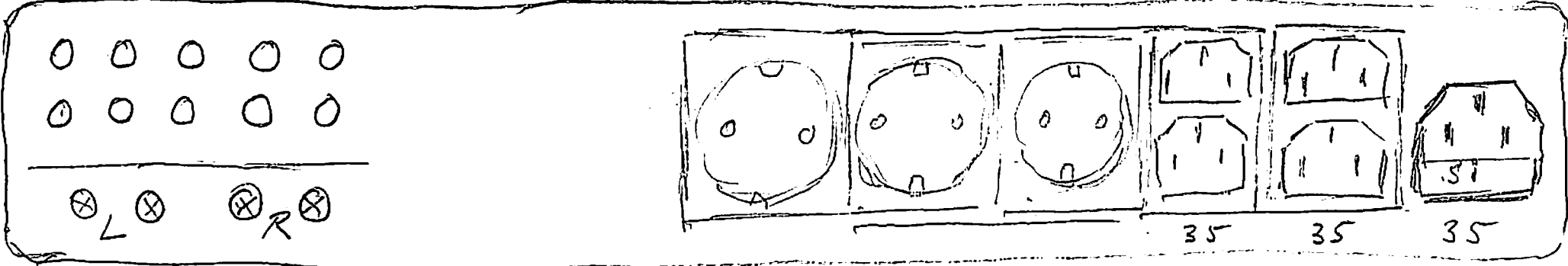

$$4 \times 50 + 35 + 35 = 270$$

19. Mai Hochzeit

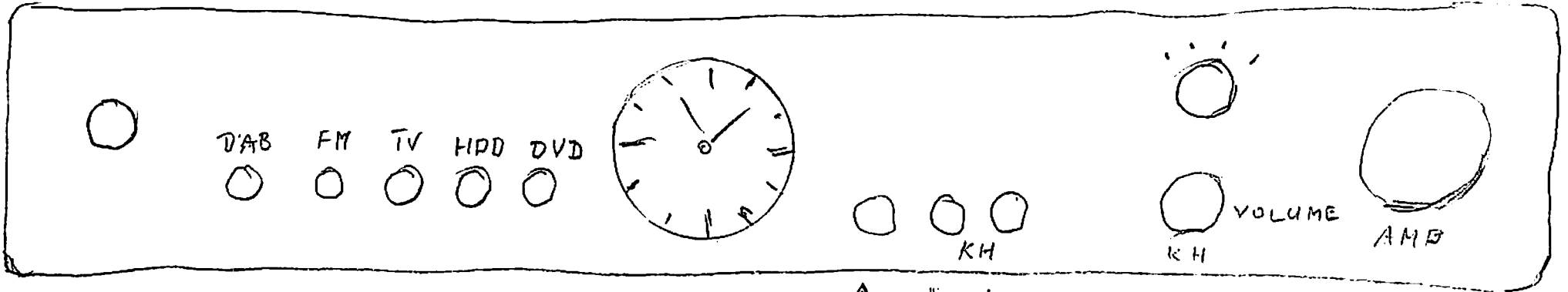

↑
AUX

↓ ↓
KH

14 x 480

2000 ¥ = 12 €

19 x 3.5
89mm

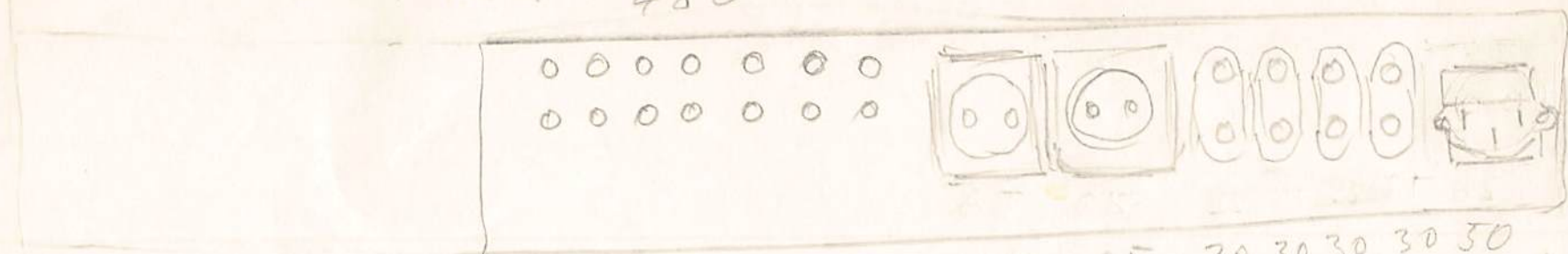

65 65 30 30 30 30 50
130 120 50

← 200 → ← 45 →

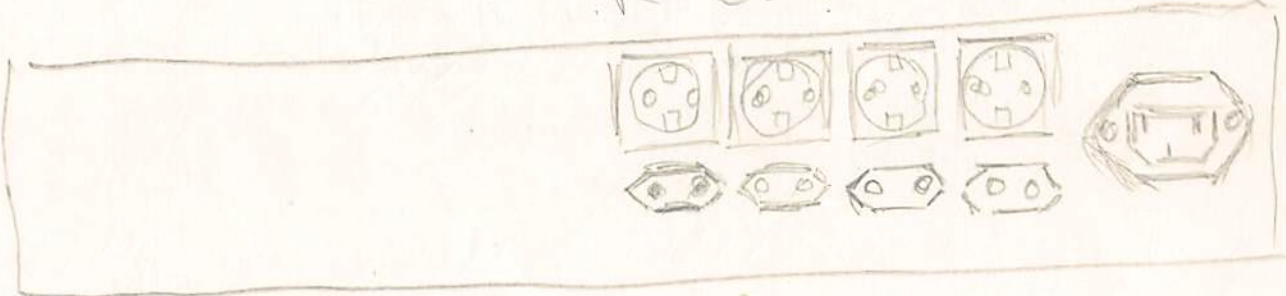

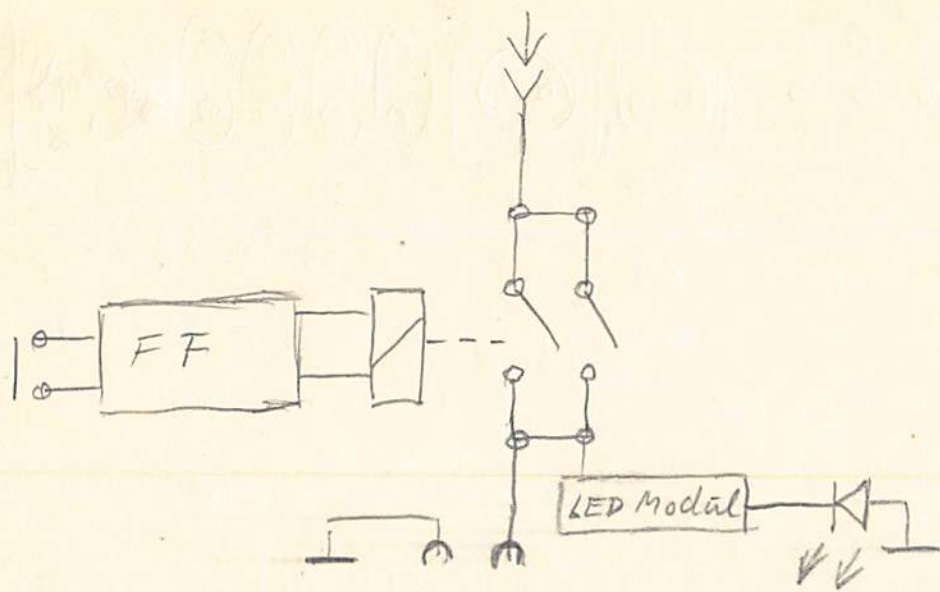

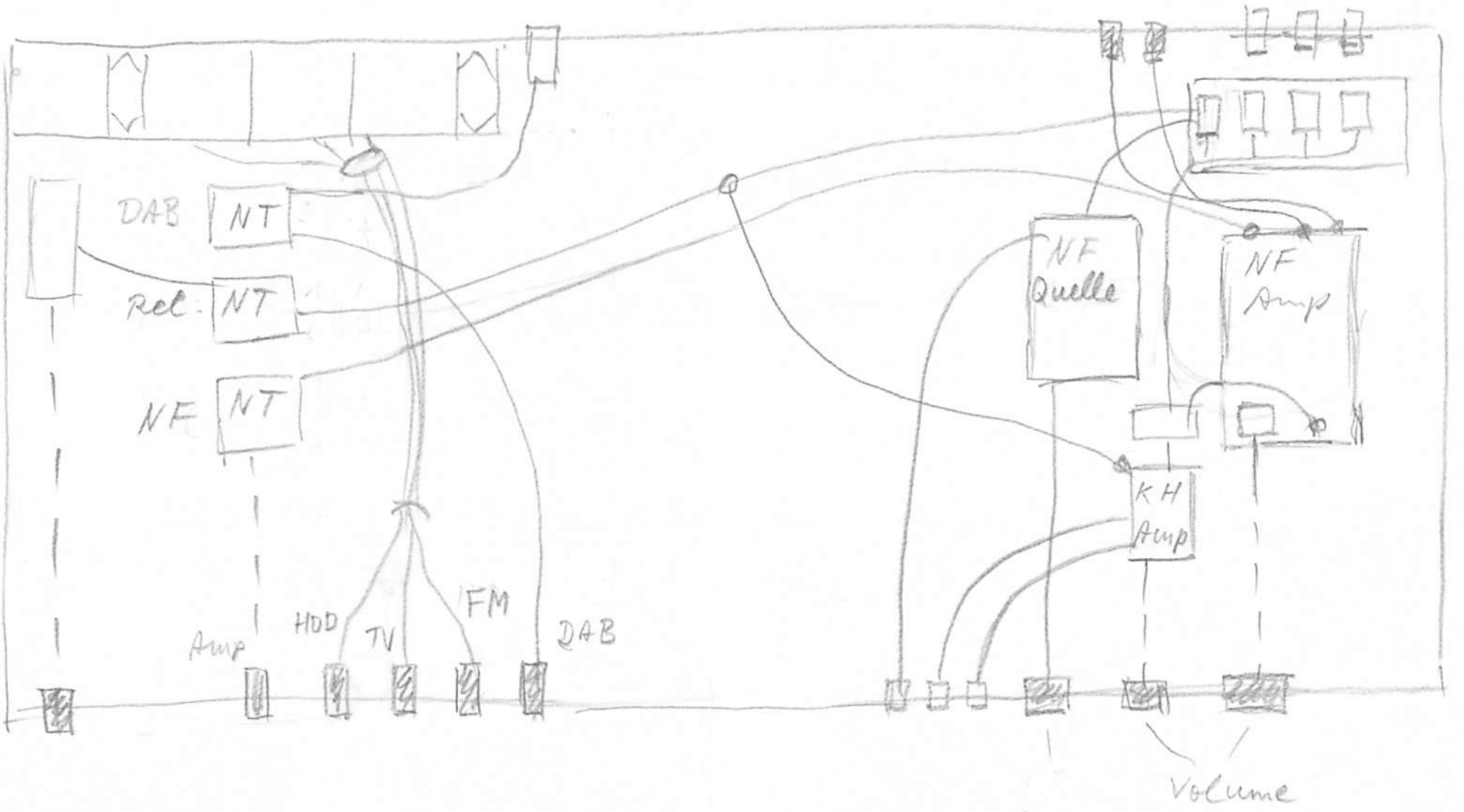

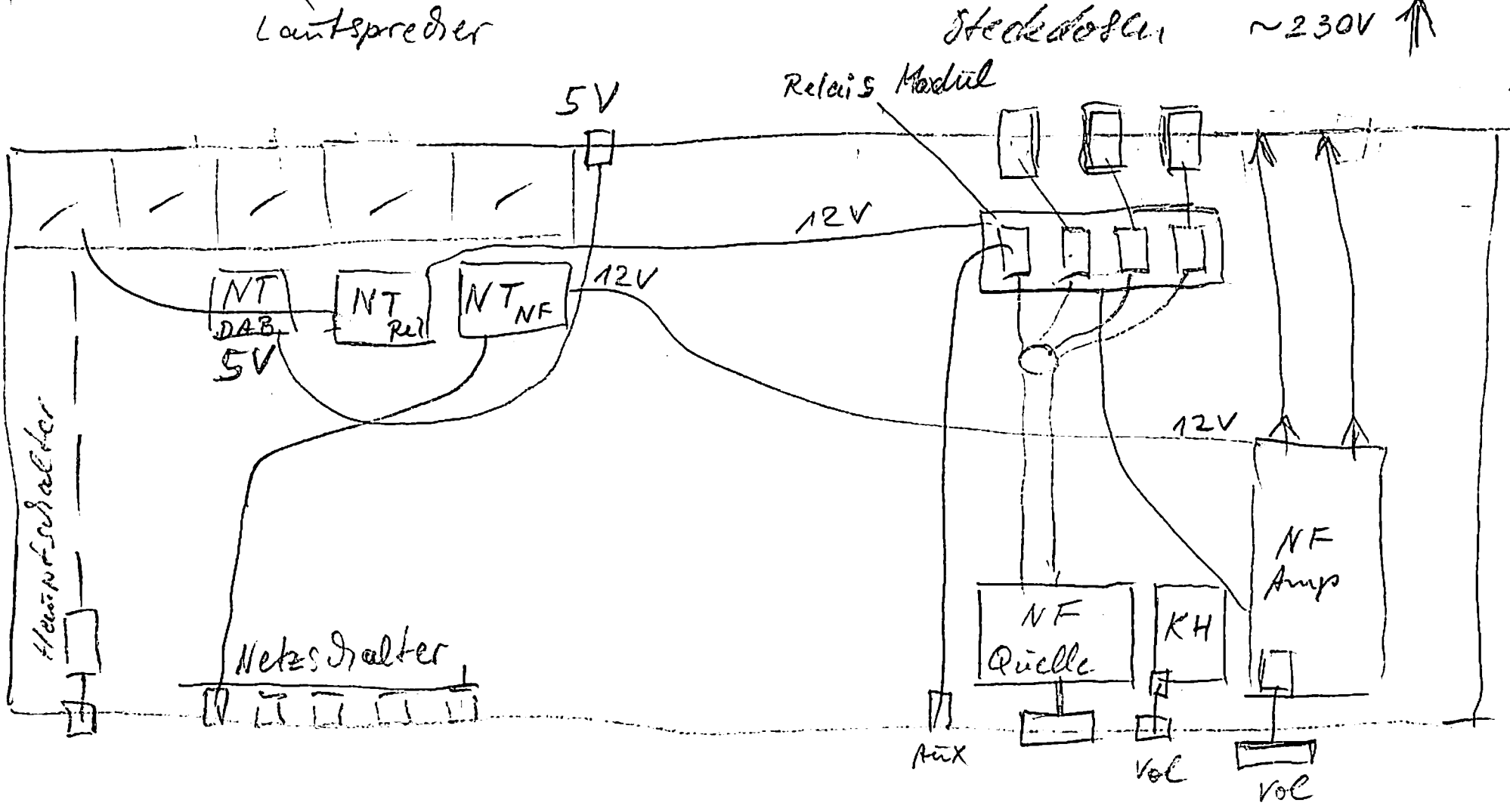
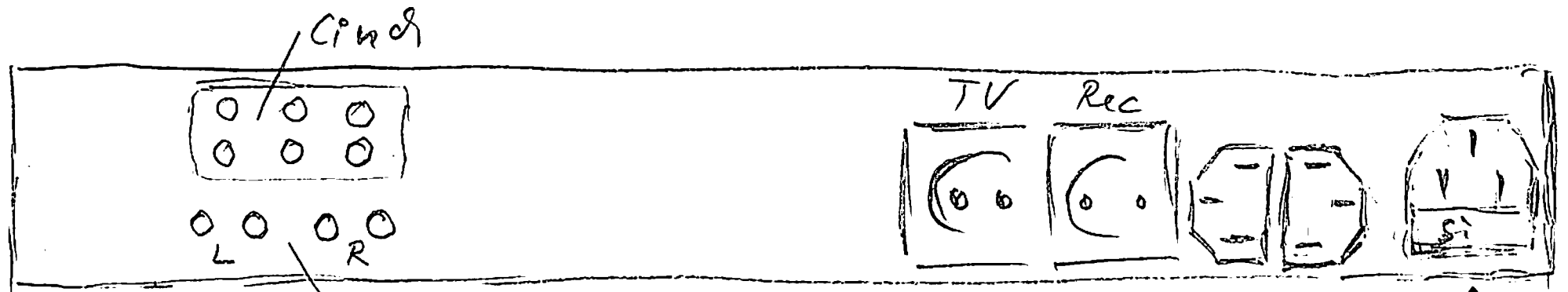

1x Hauptschalter + LED

5x Netzschalter A-Geräte + LED

T+A CD 1220 R Nathan Trensch

Krell KAV 300P

ESC 2017

1x Quellen-Wahl-Schalter + LED

1x KH-Lautstärke + LED

1x LS - " " + LED

3x Ø3,5 Klinkebuchsen

23" 7,5
24,1

≥ 48

Uhren-Modul (analog) + LED

Terresdorf TE 3/TE 10

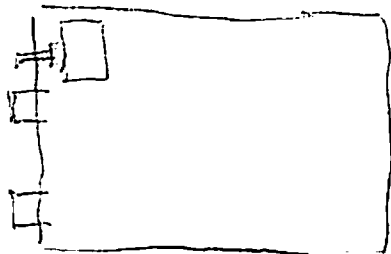
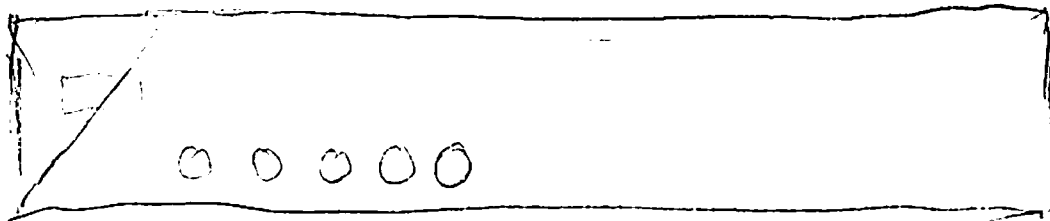
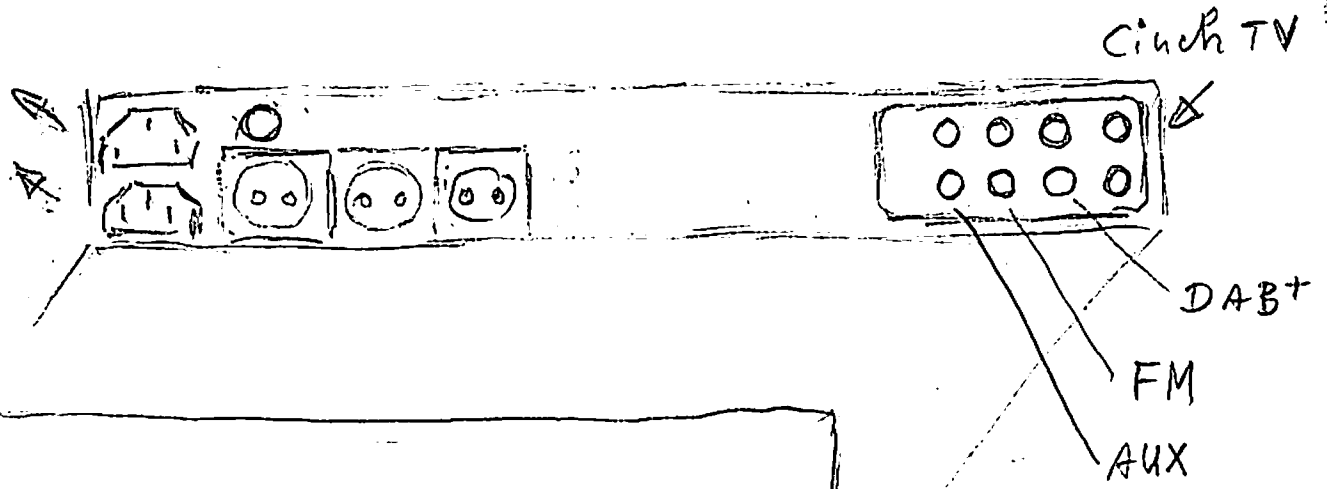
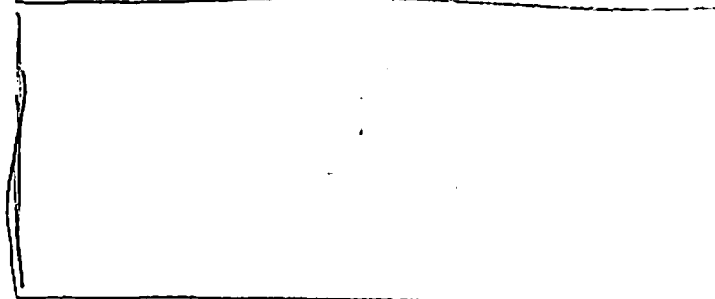
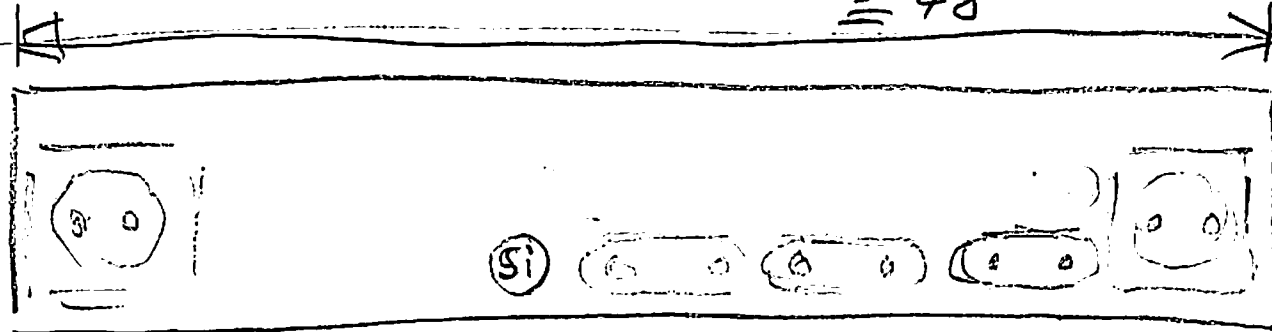

LED für Uhr

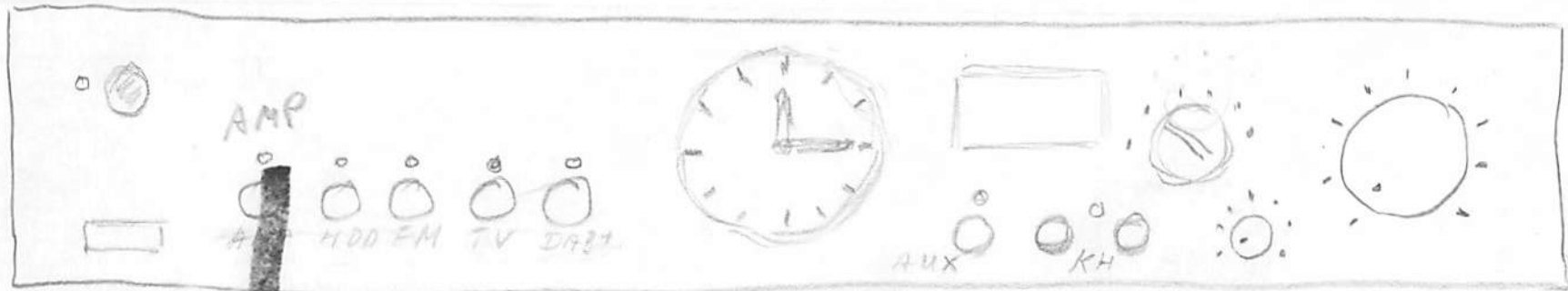

IR-KH

LED-Dimmer

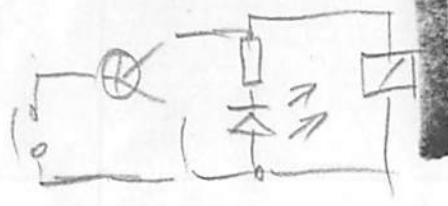
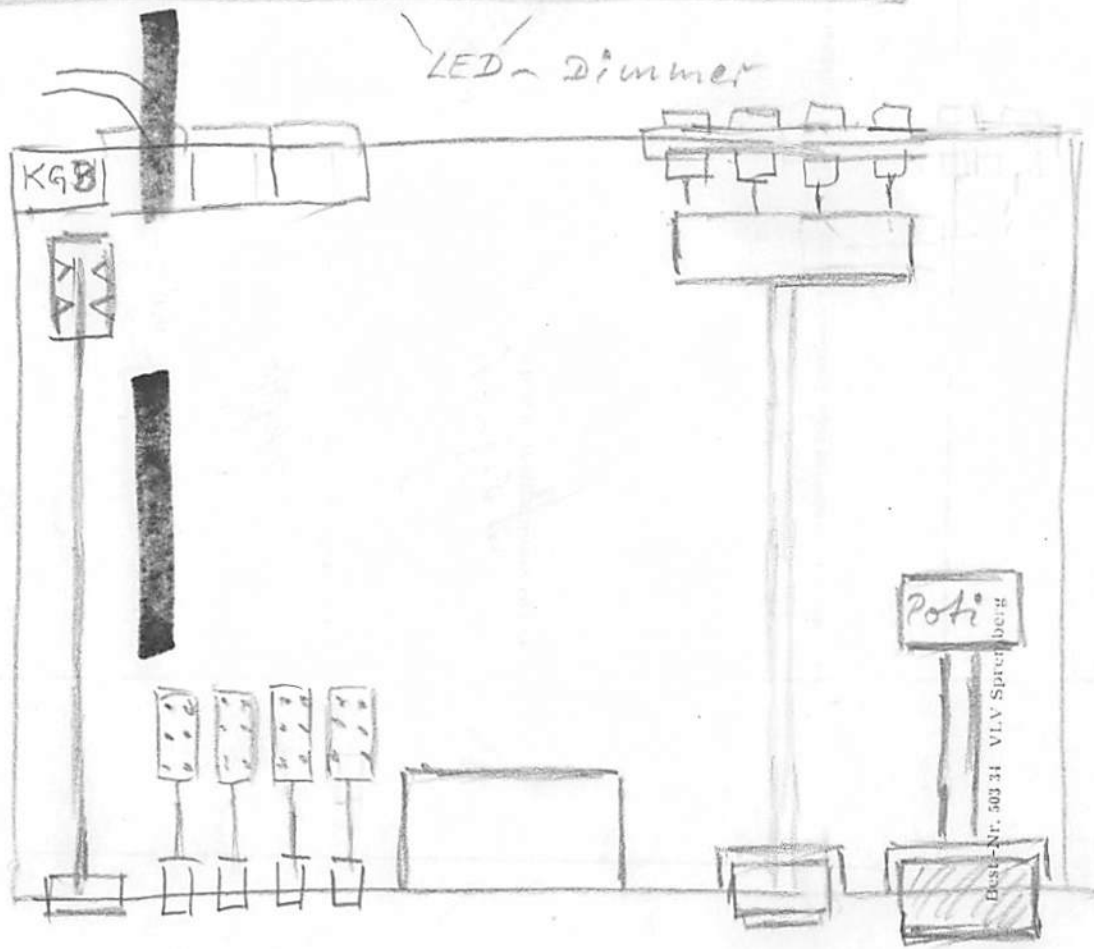

AS 310-05-DDR-2300 1-3-20 3371

Best-Nr. 503 34 VLV Sprengberg

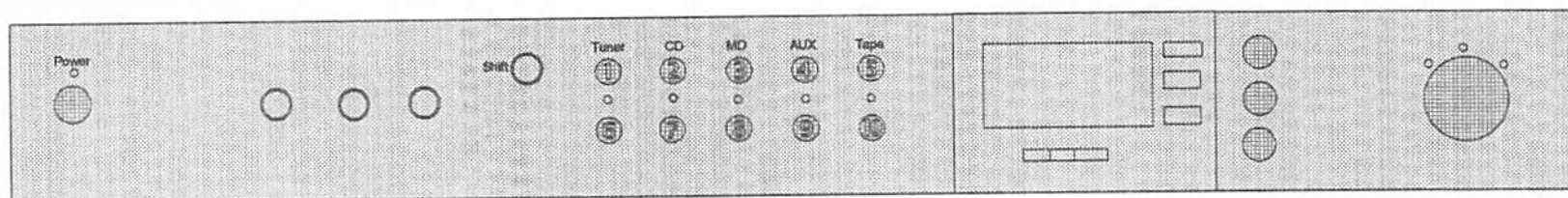



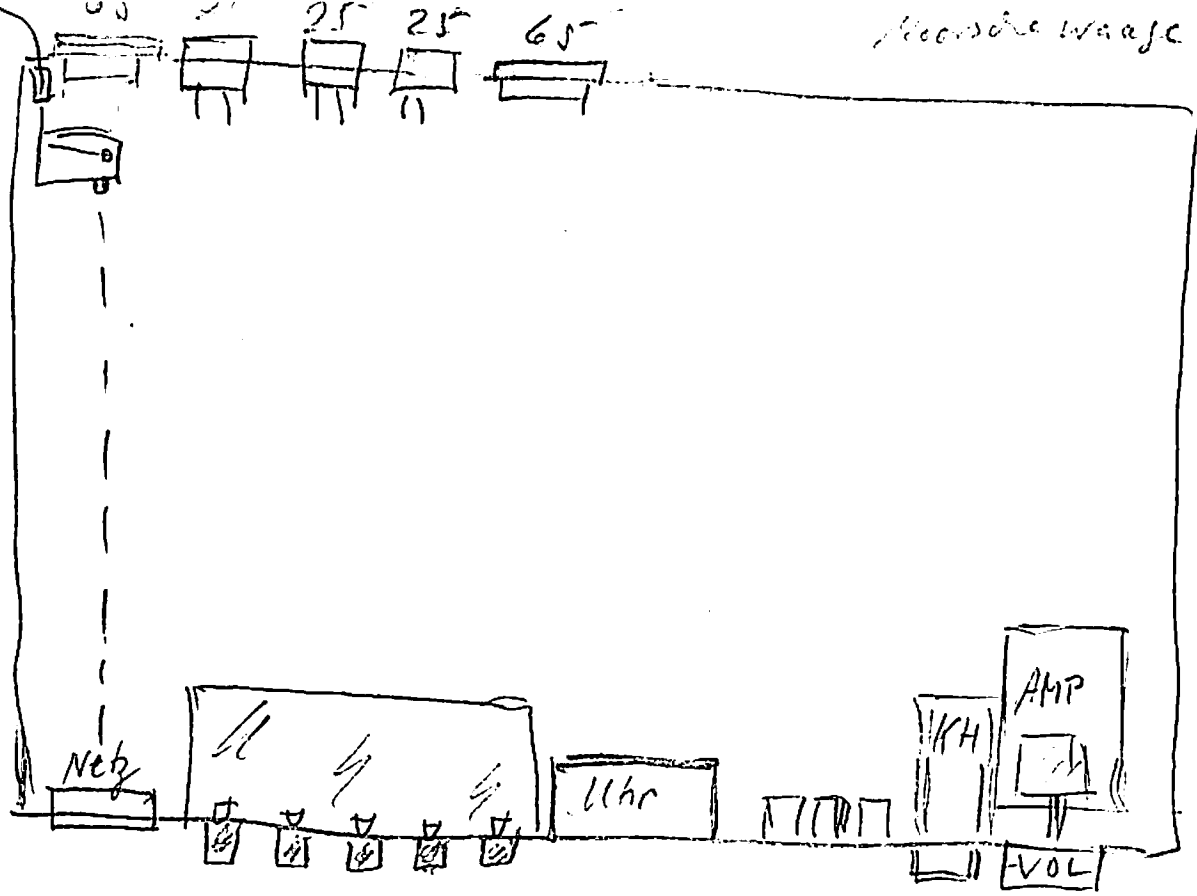

Hörschle Wäge

040
 310 (130)
 235 (75)

IR-KH

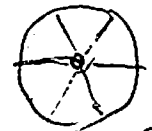

482-487 gn/bl
 487-492 türkis
 497 bl/gn

3X KG Std.
 2X Schuko

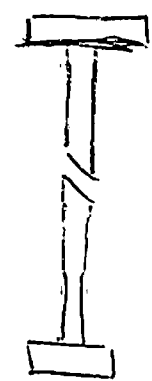

MAX 619 CSAE + hasd MT3608/2A 28V

Rel 1 Rel 2 Rel 3 Rel 4 f.lg.Br.
↓ ↓ ↓ ↓ ↙

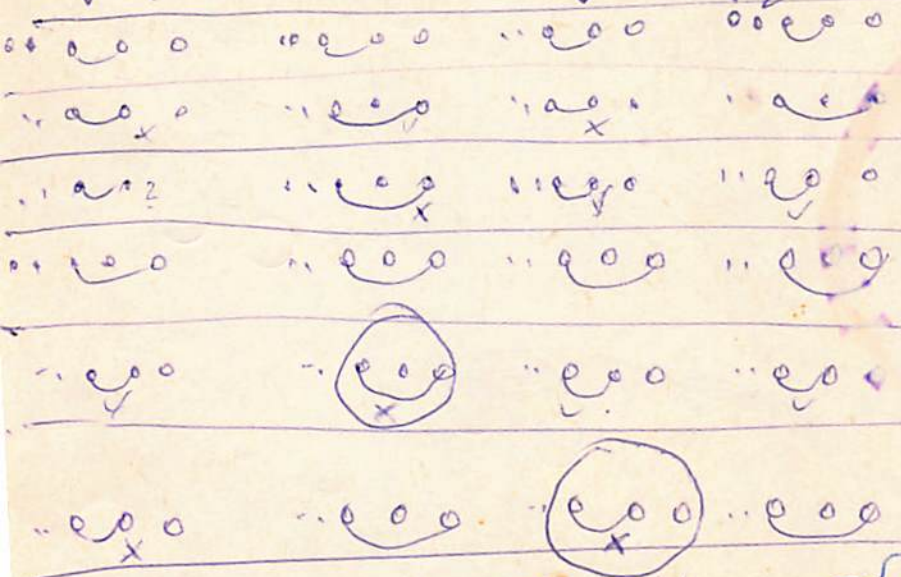

Hand
 mit Schalter lg.
 äuß. Sch. k.
 von Hand
 die Bes. Sch. k.
 mit Sch. lg.

schaltet nicht hoch
 keine lg. Br.
 schaltet nicht zurück
 (keine Kürze 2. n. ke.)
 schaltet nicht hoch
 (keine lg. Br.)



Dave Davies
 Death of a Clown

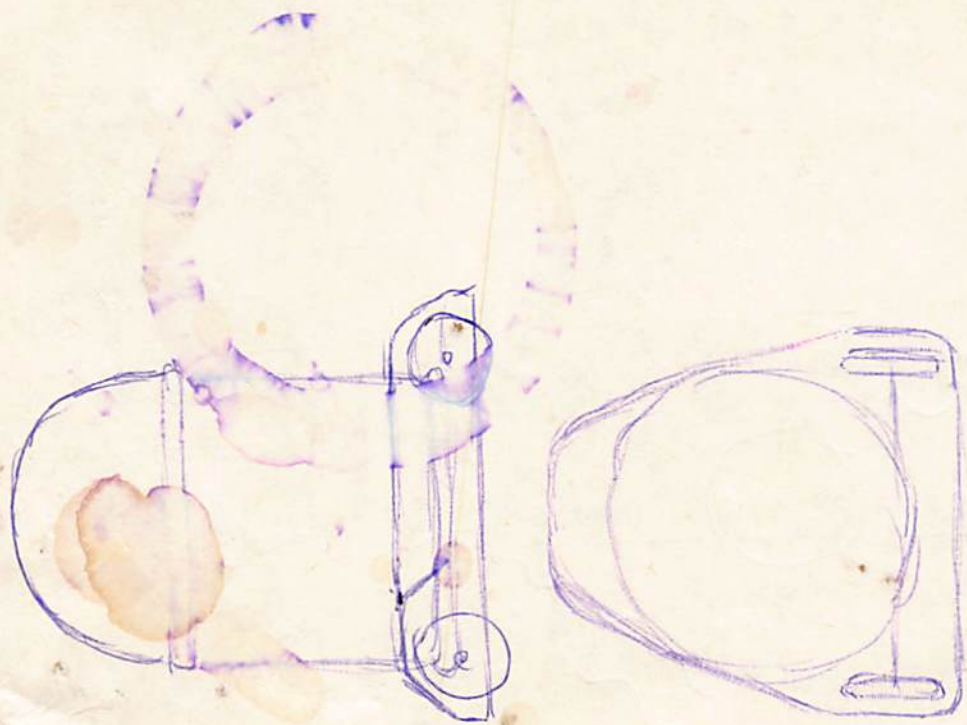

2015 ARD
 26.12
 23.78
 16.28
 13.08
 11.11

Hammerteinplatte 7

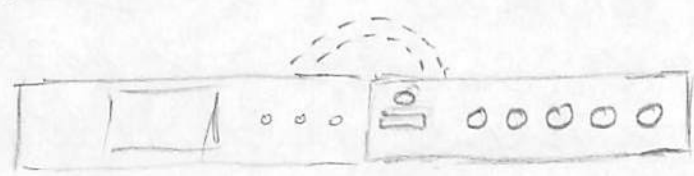

902

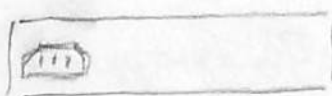

5280

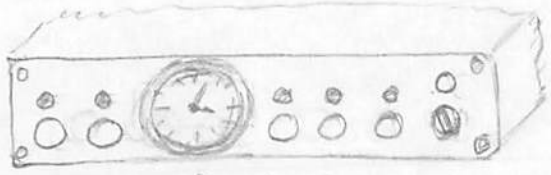
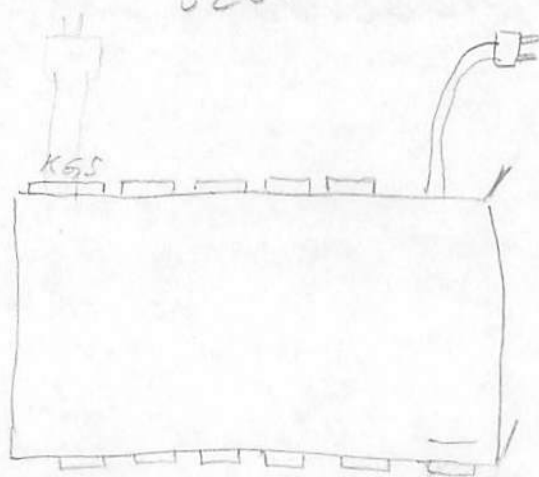

SWA 1130
 MDR 820
 MDR

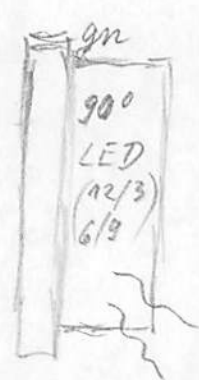

Funktionen

- 1 Ein/Aus

- 3 Ein/
- 4 /Aus

- 6 Haupt Ein/Aus

- 7 Auto Ein/Aus

MDR 1600 Lichtdesign

3 sat 1535-1700 Pizzabote, Daniel

Amp, HDD, FM
DAB+, TV

00 200 mm

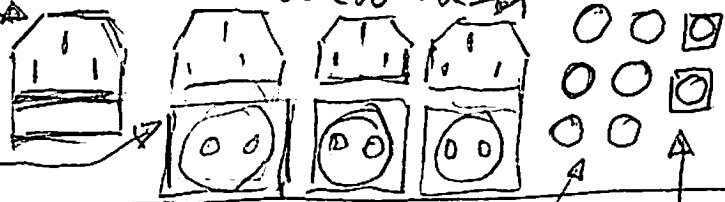

DAB+, FM, Cinch
Line In TV Toslink

